

Kitchen

Elevating
your everyday
home
experience

Kitchen

Index

Together, with Style	4
Elleci District	6
Materiali	8
Colori	10
Elleci Kitchen	12
Trend	14
Drain System	18
Smart area	20

Workstation	26
Vasche	58
Lavelli	102
Accessori	166
Miscelatori	176
Elleci Pure	182
Piani cottura	198
Elettrodomestici	214
Elleci Zero	226



Together, with Style

Elleci è una **storia collettiva**, che unisce spirito imprenditoriale, talenti individuali e sogni condivisi in un progetto ambizioso: la connessione tra progresso tecnologico e valori umanistici. Una vision forte e inconfondibile, che pone le **persone al centro** nella creazione di ogni prodotto: nasce uno **stile unico**, interpretazione moderna della sensibilità al **bello, utile e piacevole**.

elleci district

Da oltre trent'anni creiamo materiali innovativi e diamo forma a idee che migliorano la qualità della vita delle persone.

L'Elleci District è un hub tecnologico in cui ogni dipartimento sviluppa e condivide competenze specialistiche in un circolo virtuoso per accrescere il know-how aziendale.

Cuore dell'headquarter è l'Elleci Innovation Center, dove ogni giorno ricercatori, designer, ingegneri e tecnici lavorano insieme per ideare nuove soluzioni.

100.000 mq

Area totale

50.000 mq

Area di produzione

1,2

Milioni unità/anno

Capacità produttiva

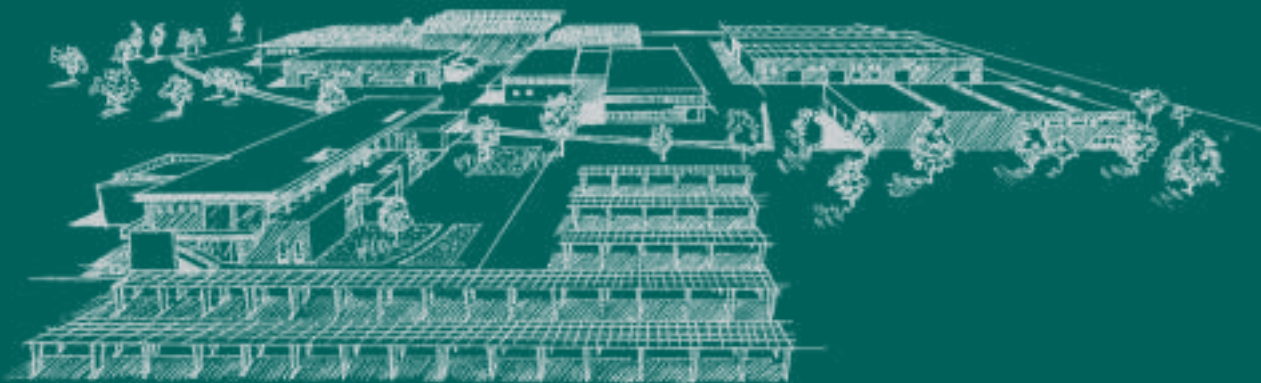

elleci plant 1

Impianto storico incentrato sulla customizzazione della produzione.

elleci plant 2

Nuovo stabilimento orientato a tecnologia sostenibile e automazione.

elleci innovation center

Laboratorio permanente di ricerca e sviluppo materiali e prodotti.

elleci care

Servizio di assistenza professionale clienti pre e post vendita.

elleci home

Area in fase di realizzazione per ospitalità, formazione e socialità.

L'innovazione è responsabilità

Il cammino verso un modello di sviluppo sostenibile è scandito da obiettivi chiari, azioni concrete e qualità certificata. È un impegno quotidiano per un mondo migliore.



Environmental

Il piano di transizione ecologica per il 2030 si fonda su materie prime riciclate e rinnovabili, energia pulita, riciclo dell'acqua, riduzione delle emissioni e dei rifiuti industriali.

Social

Per sostenere la crescita professionale e la qualità della vita dei lavoratori progettiamo formazione, welfare aziendale e nuove formule per la conciliazione lavoro-famiglia.

Governance

La sfida della sostenibilità non si limita al raggiungimento degli obiettivi a breve termine, ma consiste nel farne il driver dello sviluppo futuro dell'azienda.



Materiali
50% di materie prime riciclate e rinnovabili



Energia
50% da fonti rinnovabili



Acqua
50% riduzione del consumo idrico per la produzione

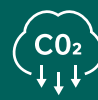

Emissioni
50% riduzione di CO₂ eq



Rifiuti
50% riduzione di rifiuti generali dal ciclo produttivo

Consulta il Bilancio di sostenibilità:
elleci.com



ISO 45001/2018
per la gestione della salute e della sicurezza sul lavoro



ISO 14001/2015
per la gestione ambientale in termini di corretto impatto dell'attività dell'azienda nell'ecosistema



ISO 9001/2015
per la gestione della qualità a garanzia della soddisfazione del cliente, in termini di continuo sviluppo e miglioramento

Materiali

Nell'Elleci Innovation Center il team di ricercatori coniuga l'expertise e la leadership tecnologica con l'innovazione. Nascono così materiali performanti, creati per avere un impatto positivo nella vita quotidiana delle persone.

GRANITEK

Il materiale creato con sabbia di quarzo, che si caratterizza per la superficie materica lievemente testurizzata e i colori naturali. La tecnologia esalta le caratteristiche intrinseche della pietra e ne migliora le prestazioni, garantendo igienicità, resistenza e longevità.

Surface
**Stony
Materic**

Colours
**Natural
Matte**

Insight
**Made
to last**

20%
Acrylic Resin

80%
Engineered
Quartz

elleci innovation center

Forging solutions by technology

KERATEK

Il materiale premium con nanotecnologie, che si distingue per la superficie piacevolmente liscia e i colori densi e opachi. Le nanoparticelle danno solidità estrema alla struttura, potenziando le performance e il valore estetico.

Surface
Silky Smooth

Colours
Deep Dusty

Insight
High Tech

20%
Microceramic

2% Nano-techs

20%
Acrylic Resin

58%
Engineered Quartz

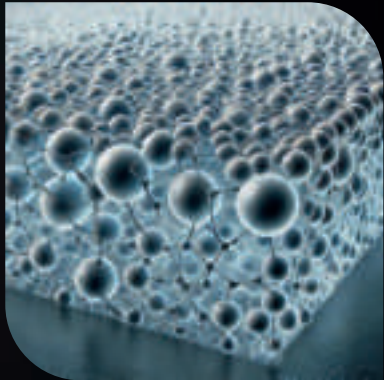

Le nanoparticelle sono il cuore nobile e innovativo del Keratek.

Colori

Caratteristiche

GRANITEK

KERATEK

	Resistente agli sbalzi termici (UNI EN 13310)	● ● ●	● ● ●
	Resistente al calore 180°C (UNI EN 13310)	● ● ●	● ● ●
	Resistente agli urti (UNI EN 13310)	● ● ●	● ● ●
	Resistente alle macchie (UNI EN 13310)	● ● ○	● ● ●
	Resistente all'acqua bollente istantanea	● ● ●	● ● ●
	Salubrità ambientale per basse emissioni chimiche (GREENGUARD)	● ● ●	● ● ●
	Sicurezza per la salute e l'ambiente	● ● ●	● ● ●
	Elevata igienicità per contatto con alimenti (NSF)	● ●	● ● ●
	Facile da pulire	● ●	● ● ●
	Superficie compatta e idrorepellente	● ●	● ● ●
	Colori intensi	● ○	● ● ●
	Estensione di garanzia	fino a 10 anni	fino a 20 anni

I nostri materiali sono certificati:



Dichiarazione ambientale
ISO 14025



Basse emissioni chimiche
UL.com/gg ul 2818



Materiale altamente
igienico

GRANITEK

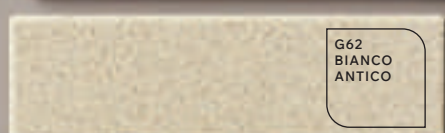
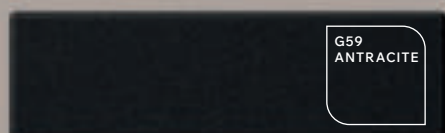
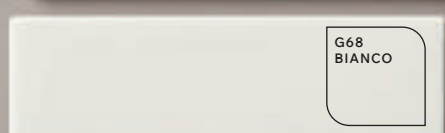
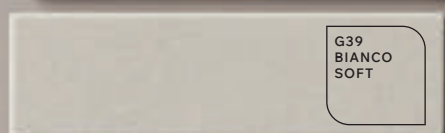
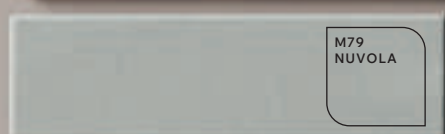
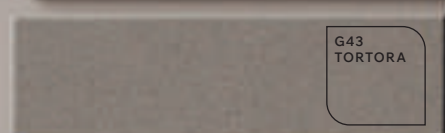
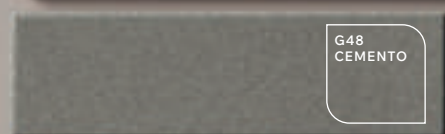
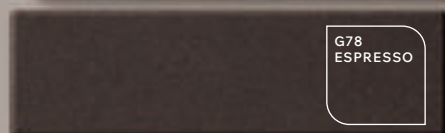

KERATEK

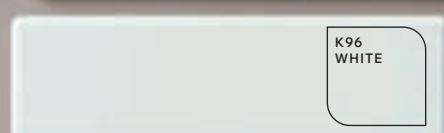
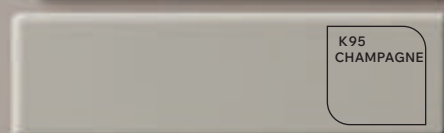
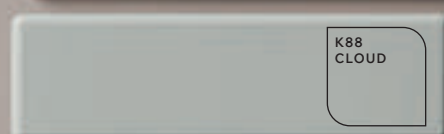
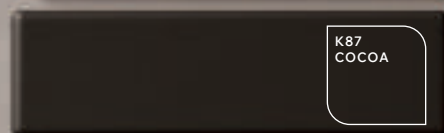
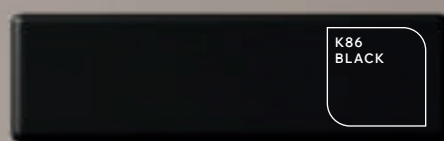

Dai neri profondi al bianco assoluto, passando per le tonalità calde e il fascino dei grigi, la bellezza materica del Granitek e l'eleganza del Keratek si declinano nelle nuance contemporanee con un approccio sensoriale differente.

A queste si affiancano i tre colori classici.



elleci kitchen

**Organizzazione, stile ed emozioni:
la cucina è progettata sulla vita delle persone.**

La cucina è il cuore della casa, dove si condividono storie, sorrisi e piccoli momenti di felicità. Una colazione veloce prima di affrontare la giornata, un pranzo in famiglia, una cena intima o con gli amici: ogni istante vissuto insieme a chi ami ha un valore immenso.

Elleci Kitchen è complice della tua serenità quotidiana con soluzioni studiate per creare spazi belli e incredibilmente pratici, che trasformano la routine in un'esperienza coinvolgente e gratificante.

La materia è protagonista. Le tonalità naturali del Granitek, le nuance intense e sofisticate del Keratek e le speciali edizioni total black valorizzano il design dei lavelli. L'area di preparazione evolve in un piano di lavoro versatile, grazie agli accessori progettati per muoversi con te e a miscelatori che abbinano funzionalità avanzate a finiture trendy. La base sottolavello diventa uno spazio ben organizzato, tecnologico e performante con il sistema di filtraggio acqua Elleci Pure e smaltimento dei rifiuti organici Elleci Zero, che rispondono al desiderio di uno stile di vita comodo e sostenibile.

Le collezioni di piani cottura in vetro e colorati, forni e piccoli elettrodomestici in family feeling ti offrono la tecnologia ideale per esprimere la tua creatività, divertirti e cucinare con amore.

In una cucina pensata per te, tutto è più facile e hai il tempo di godere di ciò che conta davvero, ogni giorno.

Trend

Eleganza total black e tonalità naturali
Novità di prodotto, colori e collezioni speciali

Il nero intenso si conferma una scelta di stile
destinata a durare ancora a lungo.

Dai lavelli e i miscelatori matt black ai raffinati
elettrodomestici il nero è il colore più amato, che dà
carattere distintivo e moderno all'ambiente.

Forno Urban plus e microonde
total black



Miscelatore Nami
gun metal



Flow Pro drain system
gun metal



Spazio workstation 600
total black



Time workstation undermount 130
total black



Piano cottura Urban glass 75
total black



Unico 305
G39 bianco soft



Forno Plano
G43 tortora



Best workstation 130
K87 cocoa

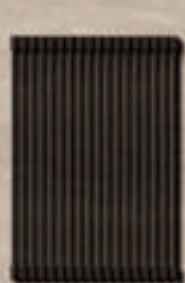

Time workstation 130 G43 tortora

Piano cottura Urban induction 80 city dune

Tra le tendenze dell'interior design domina la predilezione per i colori naturali. Bianco soft, tortora e tonalità terrose donano sensazioni di calore, autenticità e confortevolezza, ispirando un'atmosfera rilassante che invita alla convivialità.

Trend

Trend

Gun metal, nero e grigio

Una nuova finitura e accessori di tendenza

I toni dark del Black, profondo e opaco, e del nuovo Gun metal esaltano l'estetica di miscelatori e componenti in metallo. Il look ultra moderno evoca audacia, robustezza e avanguardia tecnologica.

Drainer flex 500 grey



Flow Pro
drain system
gun metal

Miscelatore Kai
gun metal



Drainer flex 440 black

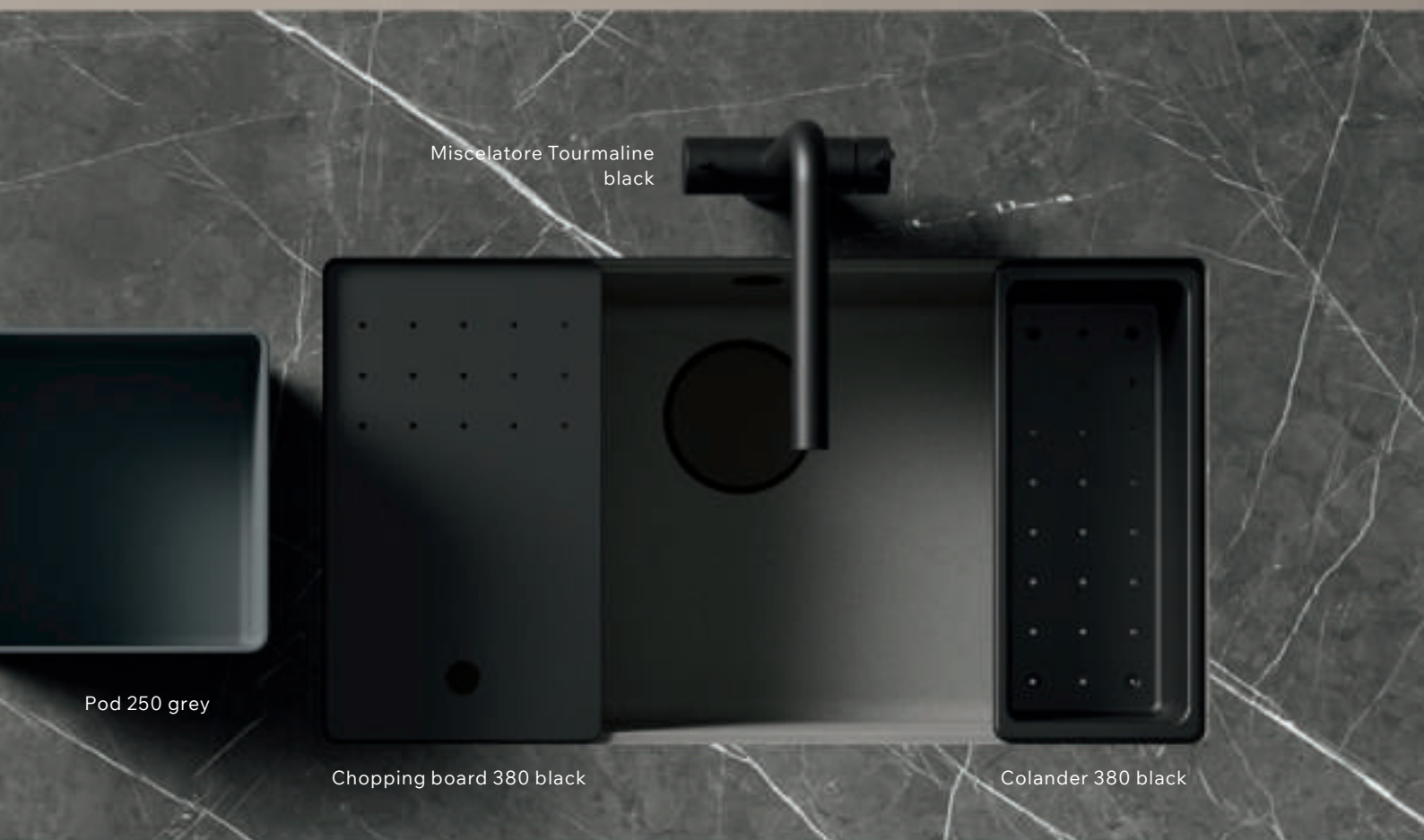

Drain System

Il sistema di scarico moderno:
bello, efficiente, pratico nell'utilizzo e nella manutenzione

Open Up

Il comando remoto push-control
dall'estetica essenziale.

Open Twist

Il comando remoto rotativo
dalla superficie ultra liscia.



Flow Pro

Flow Pro ridefinisce il concetto
di scarico e trasforma un com-
ponente tecnico in un elemento
distintivo, che raggiunge un
livello esclusivo di ergonomia,
funzionalità e valore estetico.



Black



Gun metal



Inox

I comandi remoti opzionali interagiscono con i diversi sistemi **Flow Pro**, **Flow** e **Ghost** per elevare l'esperienza di utilizzo, grazie al controllo a distanza di apertura e chiusura dello scarico.

Le tre finiture **Black**, **Gun metal** e **Inox spazzolato** impreziosiscono il design e dialogano con i complementi d'arredo dell'ambiente.

Open Up



Open Twist



Flow

Linee pulite e un tocco di stile caratterizzano Flow, che migliora il deflusso dell'acqua e l'usabilità rispetto ai sistemi di scarico tradizionali.



Black



Inox

Ghost

La cover nasconde lo scarico e diventa una soluzione di design per costruire armonie o contrasti di colore con vasca, miscelatore e accessori.



Black



Inox

Smart area

Intelligente, tecnologica, eco-friendly:
organizza la base livello con funzionalità avanzate

elleci pure

Il programma di filtrazione abbatte le sostanze nocive presenti nel sistema idrico e migliora la salubrità e il gusto dell'acqua come mai prima d'ora, grazie alla combinazione delle azioni purificanti di microfiltrazione, carboni attivi e sali d'argento.

elleci zero

Il sistema di smaltimento dell'organico libera la cucina dall'accumulo di rifiuti e dai cattivi odori. Comodo, sicuro e ultra silenzioso, il dissipatore alimentare trita e smaltisce in pochi secondi gli avanzi di cibo nella rete fognaria insieme all'acqua.



Workstation

Best



BEST 360



BEST 130



BEST 105



BEST 104

Spazio



SPAZIO 900XL



SPAZIO 900



SPAZIO 600 XL



SPAZIO 600

Time



TIME 130



TIME 105



TIME 102

Time Undermount



TIME UNDERMOUNT
130



TIME UNDERMOUNT
105

Vasche

Zen / Zen F



ZEN / ZEN F 130



ZEN / ZEN F 105



ZEN / ZEN F 102



ZEN / ZEN F 150

new

Karisma



KARISMA 120



KARISMA 105



KARISMA 120 SOTTOTOP



KARISMA 105 SOTTOTOP

Quadra



QUADRA 130



QUADRA 120

new



QUADRA 110



QUADRA 105



QUADRA 102



QUADRA 100



QUADRA 350



QUADRA 340



QUADRA 440



QUADRA 150



QUADRA 50

Quadra Sottotop



QUADRA 130 SOTTOTOP

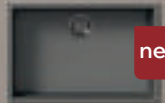

QUADRA 120 SOTTOTOP

new

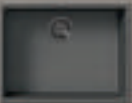

QUADRA 110 SOTTOTOP



QUADRA 105 SOTTOTOP



QUADRA 102 SOTTOTOP



QUADRA 100 SOTTOTOP



QUADRA 350 SOTTOTOP



QUADRA 340 SOTTOTOP



QUADRA 440 SOTTOTOP



QUADRA 150 SOTTOTOP



QUADRA 50 SOTTOTOP

Fox



FOX 360

new design



FOX 200



FOX ROUND

Lavelli

Best



BEST 500



BEST 480



BEST 475



BEST 450



BEST 450 SOTTOTOP

Unico



UNICO 500



UNICO 480



UNICO 475

new



UNICO 410



UNICO 310



UNICO 305

new



UNICO 300



UNICO 125



UNICO CORNER

Ego



EGO 500



EGO 480



EGO 400



EGO 450



EGO ROUND

Easy



EASY 500



EASY 480



EASY 475

new



EASY 310



EASY 300



EASY 290



EASY 135



EASY ROUND 600

Life



Master



Black Edition new

Best



Time / Time Undermount



Unico



Best WORKSTATION

Una postazione moderna e super efficiente: Best workstation offre massima capienza e tre livelli di lavoro per ospitare incastri perfetti e guide di scorrimento degli accessori, che facilitano le attività di preparazione.

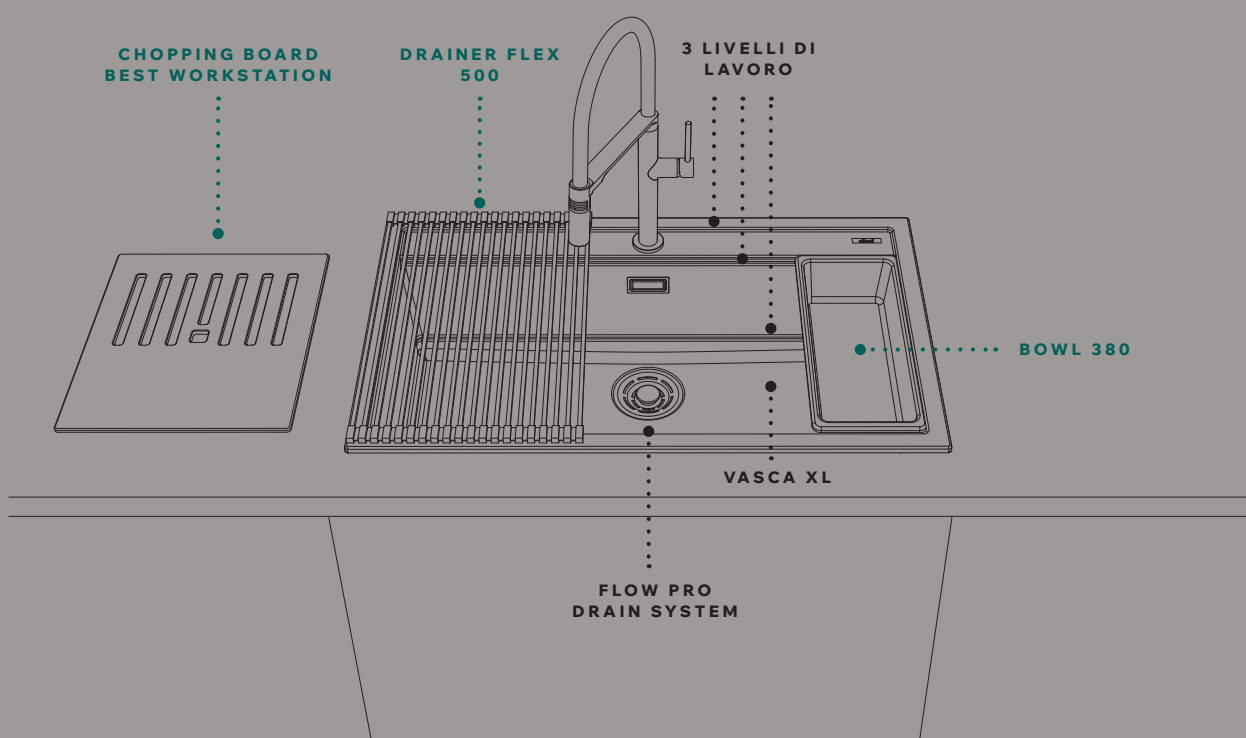

MODELLI BEST WORKSTATION

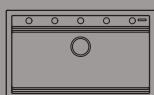

Best 360

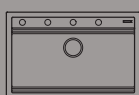

Best 130



Best 105



Best 104



Lavello Best 360 - K86 Black
Miscelatore Nami - GM Gun metal

GRANITEK



KERATEK



Best

WORKSTATION

La cucina è il luogo in cui, ogni giorno, nutri il piacere delle cose semplici e genuine o ti diverti a esplorare nuovi sapori. Un'area di lavoro ben organizzata dà slancio alla creatività e rende ancor più bello prenderti cura di te e di chi ami.





TOTAL BLACK, UN'EDIZIONE SPECIALE CARATTERIZZATA DAL NERO INTENSO
PER ESALTARE LA LINEA ESTETICA DI BEST WORKSTATION

Best WORKSTATION

Best 360

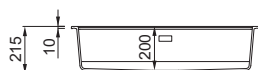
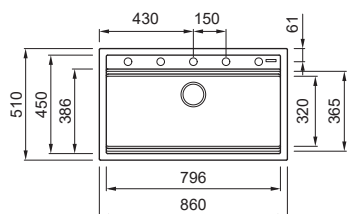

LAVELLO 1 VASCA

Dimensioni	860 x 510 mm
Base	900 mm
Foro da incasso	840 x 480 mm
Profondità vasca	200 mm
Banco rubinetteria	Si
Installazione	Sopratop

GRANITEK

€ 540

- G40** Nero LGB36040
- G78** Espresso LGB36078
- G48** Cemento LGB36048
- G43** Tortora LGB36043
- M79** Nuvola LMB36079
- G39** Bianco Soft LGB36039
- G68** Bianco LGB36068
- G59** Antracite LGB36059
- G51** Avena LGB36051

KERATEK

€ 710

- K86** Black LKB36086
- K87** Cocoa LKB36087
- K99** Concrete LKB36099
- K89** Dove LKB36089
- K88** Cloud LKB36088
- K95** Champagne LKB36095
- K96** White LKB36096

Best 130

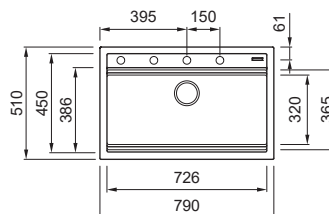

LAVELLO 1 VASCA

Dimensioni	790 x 510 mm
Base	800 mm
Foro da incasso	770 x 480 mm
Profondità vasca	200 mm
Banco rubinetteria	Si
Installazione	Sopratop

GRANITEK

€ 530

- G40** Nero LGB13040
- G78** Espresso LGB13078
- G48** Cemento LGB13048
- G43** Tortora LGB13043
- M79** Nuvola LMB13079
- G39** Bianco Soft LGB13039
- G68** Bianco LGB13068
- G59** Antracite LGB13059
- G51** Avena LGB13051

KERATEK

€ 690

- K86** Black LKB13086
- K87** Cocoa LKB13087
- K99** Concrete LKB13099
- K89** Dove LKB13089
- K88** Cloud LKB13088
- K95** Champagne LKB13095
- K96** White LKB13096

Best WORKSTATION

Best 105

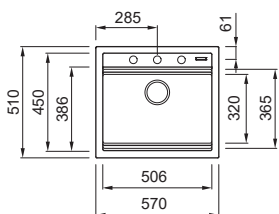

Best 104

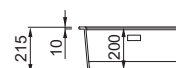
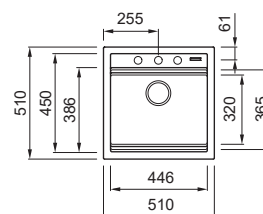
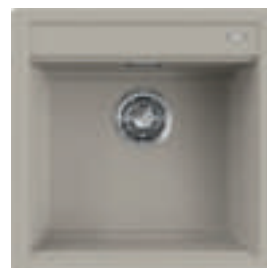

LAVELLO 1 VASCA

Dimensioni	570 x 510 mm
Base	600 mm
Foro da incasso	550 x 480 mm
Profondità vasca	200 mm
Banco rubinetteria	Si
Installazione	Sopratop

LAVELLO 1 VASCA

Dimensioni	510 x 510 mm
Base	500 600 mm se inizio composizione
Foro da incasso	490 x 480 mm
Profondità vasca	200 mm
Banco rubinetteria	Si
Installazione	Sopratop

GRANITEK

€ 490

- G40** Nero LGB10540
- G78** Espresso LGB10578
- G48** Cemento LGB10548
- G43** Tortora LGB10543
- M79** Nuvola LMB10579
- G39** Bianco Soft LGB10539
- G68** Bianco LGB10568
- G59** Antracite LGB10559
- G51** Avena LGB10551

KERATEK

€ 640

- K86** Black LKB10586
- K87** Cocoa LKB10587
- K99** Concrete LKB10599
- K89** Dove LKB10589
- K88** Cloud LKB10588
- K95** Champagne LKB10595
- K96** White LKB10596

GRANITEK

€ 480

- G40** Nero LGB10440
- G78** Espresso LGB10478
- G48** Cemento LGB10448
- G43** Tortora LGB10443
- M79** Nuvola LMB10479
- G39** Bianco Soft LGB10439
- G68** Bianco LGB10468
- G59** Antracite LGB10459
- G51** Avena LGB10451

KERATEK

€ 630

- K86** Black LKB10486
- K87** Cocoa LKB10487
- K99** Concrete LKB10499
- K89** Dove LKB10489
- K88** Cloud LKB10488
- K95** Champagne LKB10495
- K96** White LKB10496

Best WORKSTATION

Best 360 Total black

new

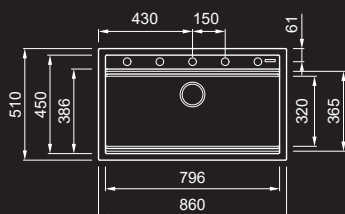

LAVELLO 1 VASCA

Dimensioni	860 x 510 mm
Base	900 mm
Foro da incasso	840 x 480 mm
Profondità vasca	200 mm
Banco rubinetteria	Si
Installazione	Sopratop

GRANITEK

€ 570

G40 Nero LGB36040BKM

KERATEK

€ 740

K86 Black LKB36086BKM

Best 130 Total black

new

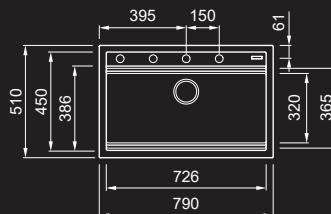

LAVELLO 1 VASCA

Dimensioni	790 x 510 mm
Base	800 mm
Foro da incasso	770 x 480 mm
Profondità vasca	200 mm
Banco rubinetteria	Si
Installazione	Sopratop

GRANITEK

€ 560

G40 Nero LGB13040BKM

KERATEK

€ 720

K86 Black LKB13086BKM

Best WORKSTATION

Best 105 Total black **new**

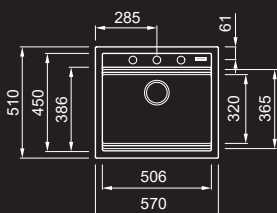

LAVELLO 1 VASCA

Dimensioni	570 x 510 mm
Base	600 mm
Foro da incasso	550 x 480 mm
Profondità vasca	200 mm
Banco rubinetteria	Si
Installazione	Sopratop

GRANITEK

€ 520

G40 Nero
LGB10540BKM

KERATEK

€ 670

K86 Black
LKB10586BKM

Best 104 Total black **new**

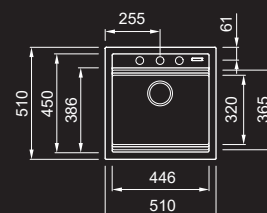

LAVELLO 1 VASCA

Dimensioni	510 x 510 mm
Base	500 600 mm se inizio composizione
Foro da incasso	490 x 480 mm
Profondità vasca	200 mm
Banco rubinetteria	Si
Installazione	Sopratop

GRANITEK

€ 510

G40 Nero
LGB10440BKM

KERATEK

€ 660

K86 Black
LKB10486BKM

Best WORKSTATION

IDEE DI STILE

Nami new



● GM Gun metal
MOKNAMGM € 400

Caratteristiche tecniche ed altre finiture a pag. 185

COMPATIBILITÀ ACCESSORI LAVELLO

CHOPPING BOARD
BEST WORKSTATION



● BK Black
ATH073BK € 115
● QU Quercia
ATH073QU € 115
● WD Wood
ATH073WD € 115

TUTTI I MODELLI

DRAINER FLEX
500

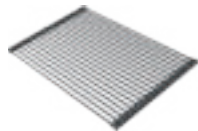

● BK Black
ARS023BK € 90
● GR Grey
ARS023GR € 90

TUTTI I MODELLI

COLANDER
380



● BK Black
AVP038BK € 65
● GR Grey
AVP038GR € 65

TUTTI I MODELLI

BOWL 380



● BK Black
ABP038BK € 65
● GR Grey
ABP038GR € 65

TUTTI I MODELLI

SOAP DISPENSER
TONDO



● BK Black
ADI02304BK € 70
● GM Gun metal
ADI02304GM € 70
● CR Cromo
ADI02304CR € 60

TUTTI I MODELLI

SOAP DISPENSER
QUADRATO



● CR Cromo
ADI02301 € 100

TUTTI I MODELLI

POD 250



● BK Black
APS250BK € 80
● GR Grey
APS250GR € 80

DRAIN SYSTEM

FLOW PRO SYSTEM



● BK Black
KITWPT-F-1VSELL-BK € 115
● GM Gun metal
KITWPT-F-1VSELL-GM € 100
● IN Inox
KITWPT-F-1VSELL-IN € 50

TUTTI I MODELLI

FLOW PRO OPEN UP



● BK Black
KITASP-F-1VSELL-BK € 150
● GM Gun metal
KITASP-F-1VSELL-GM € 150
● IN Inox
KITASP-F-1VSELL-IN € 80

TUTTI I MODELLI

FLOW PRO OPEN TWIST



● BK Black
KITASPT-F-1VSELL-BK € 150
● IN Inox
KITASPT-F-1VSELL-IN € 80

TUTTI I MODELLI

ELLECI ZERO



Serie 60
TDZ060GR € 380
Serie 100
TDZ100GR € 450

TUTTI I MODELLI

Best

WORKSTATION

Lavello Best 360 - K86 Black
Miscelatore Wave - BK Black



Spazio

WORKSTATION



reddot winner 2023

L'ispirazione farmhouse incontra il lifestyle contemporaneo e disegna Spazio: la vasca, infinitamente pratica, è definita da geometrie pulite e dalla particolare installazione in appoggio con il bordo a vista che sporge dal mobile.

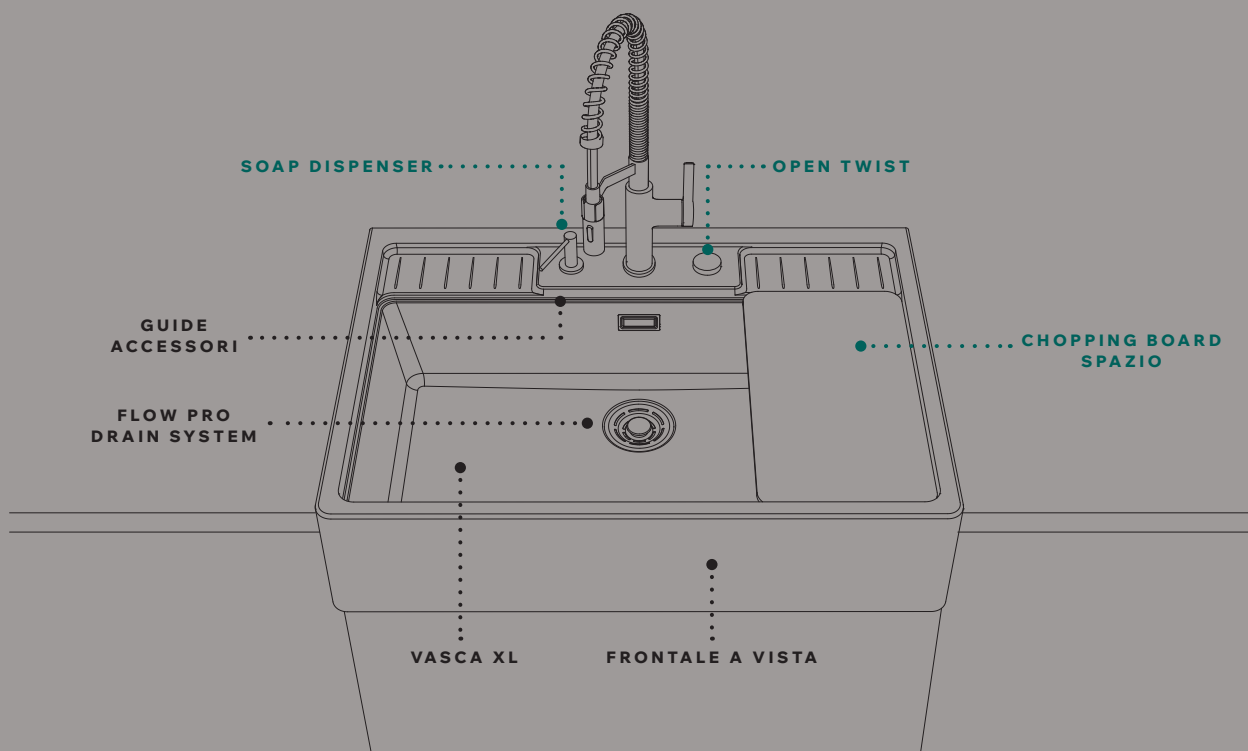

MODELLI SPAZIO WORKSTATION

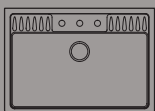

Spazio 900

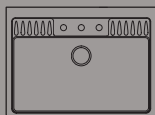

Spazio 900 Extra

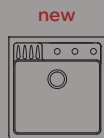

Spazio 600



Spazio 600 Extra



Lavello Spazio 900 - K96 White
Miscelatore River-CR Cromo

KERATEK

K86
BLACK

K87
COCOA

K99
CONCRETE

K89
DOVE

K88
CLOUD

K95
CHAMPAGNE

K96
WHITE

Spazio WORKSTATION

Oggi come un tempo, è in cucina che abitano gusto, emozioni e ospitalità. La collezione Spazio porta grande comfort e un'atmosfera accogliente nelle abitazioni moderne, con un design lineare che sposa i diversi stili d'arredo.



NEW
SPAZIO 600



SIA SPAZIO 900 CHE IL NUOVO MODELLO SPAZIO 600 SONO DISPONIBILI NELLA DUPLICE
VERSIONE "STANDARD" ED "EXTRA" PER GARANTIRE L'INSTALLAZIONE OTTIMALE
SU TOP DA 60 E 64 CM

Spazio WORKSTATION

Spazio 900 | Spazio 900 EXTRA

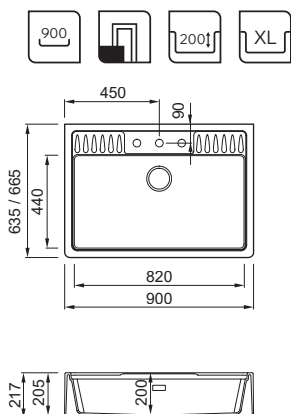

Spazio 600 | Spazio 600 EXTRA

new

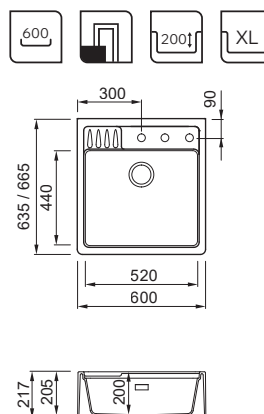

LAVELLO 1 VASCA

Dimensioni Spazio 900 900 x 635 mm
 Dimensioni Spazio 900 XL 900 x 665 mm
 Base 900 mm
 Foro da incasso Da dima
 Profondità vasca 200 mm
 Banco rubinetteria Sì
 Installazione Appoggio

KERATEK

€ 1.200

Spazio 900

- K86** Black LKS90086
- K87** Cocoa LKS90087
- K99** Concrete LKS90099
- K89** Dove LKS90089
- K88** Cloud LKS90088
- K95** Champagne LKS90095
- K96** White LKS90096

KERATEK

€ 1.200

Spazio 900 EXTRA

- K86** Black LKS90086XLP
- K87** Cocoa LKS90087XLP
- K99** Concrete LKS90099XLP
- K89** Dove LKS90089XLP
- K88** Cloud LKS90088XLP
- K95** Champagne LKS90095XLP
- K96** White LKS90096XLP

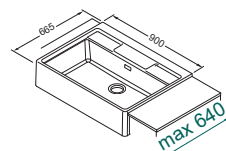
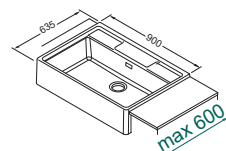

LAVELLO 1 VASCA

Dimensioni Spazio 600 600 x 635 mm
 Dimensioni Spazio 600 XL 600 x 665 mm
 Base 600 mm
 Foro da incasso Da dima
 Profondità vasca 200 mm
 Banco rubinetteria Sì
 Installazione Appoggio

KERATEK

€ 950

Spazio 600

- K86** Black LKS60086
- K87** Cocoa LKS60087
- K99** Concrete LKS60099
- K89** Dove LKS60089
- K88** Cloud LKS60088
- K95** Champagne LKS60095
- K96** White LKS60096

KERATEK

€ 950

Spazio 600 EXTRA

- K86** Black LKS60086XLP
- K87** Cocoa LKS60087XLP
- K99** Concrete LKS60099XLP
- K89** Dove LKS60089XLP
- K88** Cloud LKS60088XLP
- K95** Champagne LKS60095XLP
- K96** White LKS60096XLP

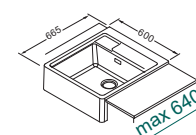
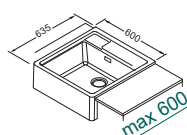

Spazio WORKSTATION

IDEE DI STILE

River new



Caratteristiche tecniche ed altre finiture a pag. 184

- GM Gun metal MOKRIVGM € 370

COMPATIBILITÀ ACCESSORI LAVELLO

CHOPPING BOARD SPAZIO



- BK Black ATH123BK € 100
- WD Wood ATH123WD € 100

TUTTI I MODELLI

SOAP DISPENSER TONDO



- BK Black ADI02304BK € 70
- GM Gun metal ADI02304GM € 70
- CR Cromo ADI02304CR € 60

TUTTI I MODELLI

SOAP DISPENSER QUADRATO



- CR Cromo ADI02301 € 100

TUTTI I MODELLI

POD 250



- BK Black APS250BK € 80
- GR Grey APS250GR € 80

DRAIN SYSTEM

FLOW PRO SYSTEM



- BK Black KITWPT-F-1VSELL-BK € 115
- GM Gun metal KITWPT-F-1VSELL-GM € 100
- IN Inox KITWPT-F-1VSELL-IN € 50

TUTTI I MODELLI

FLOW PRO OPEN UP



- BK Black KITASP-F-1VSELL-BK € 150
- GM Gun metal KITASP-F-1VSELL-GM € 150
- IN Inox KITASP-F-1VSELL-IN € 80

TUTTI I MODELLI

FLOW PRO OPEN TWIST



- BK Black KITASPT-F-1VSELL-BK € 150
- IN Inox KITASPT-F-1VSELL-IN € 80

TUTTI I MODELLI

ELLECI ZERO



- Serie 60 TDZ060GR € 380
- Serie 100 TDZ100GR € 450

TUTTI I MODELLI

Time

WORKSTATION

La nuova collezione di vasche Time workstation, in Granitek, ottimizza lo spazio, organizza il lavoro e si distingue per i dettagli di stile. Grazie al set di accessori disegnato su misura, ogni elemento ha il suo posto e la sua funzione.

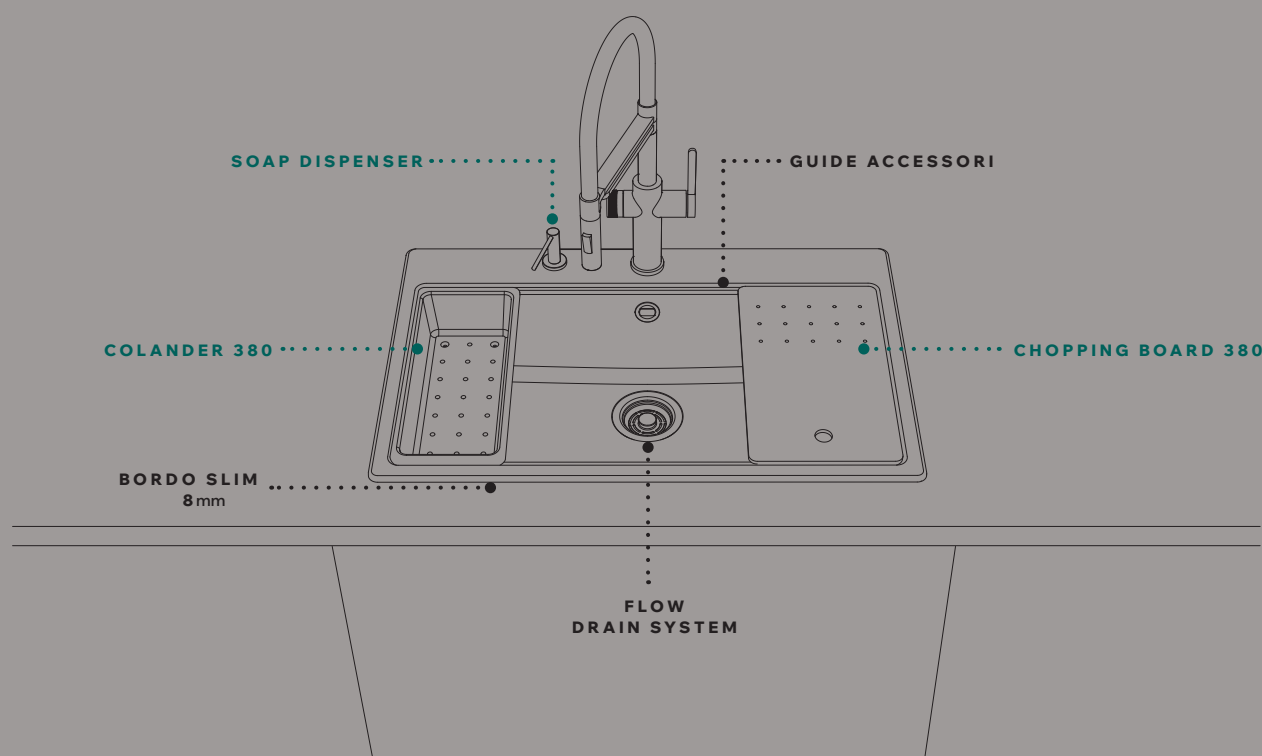

MODELLI TIME WORKSTATION

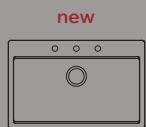

Time 130



Time 105



Time 102

NEW
COLLECTION



Lavello Time 130 - G48 Cemento
Miscelatore Ventum - BK Black

GRANITEK

G40
NERO

G78
ESPRESSO

G48
CEMENTO

G43
TORTORA

G39
BIANCO
SOFT

G68
BIANCO

Time

WORKSTATION

Il banco rubinetteria diviene un'area operativa che ospita miscelatore, comandi e piccoli complementi come il dosasapone, mentre il bordo interno permette lo scorrimento degli accessori, creando un'area di lavoro dinamica e personalizzabile.



NEW
COLLECTION

TIME CELEBRA IL PIACERE DEI GESTI QUOTIDIANI E TRASFORMA I MOMENTI SEMPLICI DELLA GIORNATA IN UN TEMPO PENSATO PER DIVENTARE STRAORDINARIO.

Time WORKSTATION

Time 130 **new**

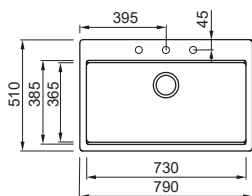

LAVELLO 1 VASCA

Dimensioni	790 x 510 mm
Base	800 mm
Foro da incasso	770 x 480 mm
Profondità vasca	180 mm
Banco rubinetteria	Si
Installazione	Sopratop

GRANITEK

€ 460

- G40 Nero
LG213040
- G78 Espresso
LG213078
- G48 Cemento
LG213048
- G43 Tortora
LG213043
- G39 Bianco Soft
LG213039
- G68 Bianco
LG213068

Time 105 **new**

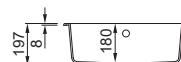
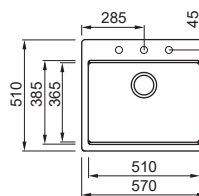

LAVELLO 1 VASCA

Dimensioni	570 x 510 mm
Base	600 mm
Foro da incasso	550 x 480 mm
Profondità vasca	180 mm
Banco rubinetteria	Si
Installazione	Sopratop

GRANITEK

€ 420

- G40 Nero
LG210540
- G78 Espresso
LG210578
- G48 Cemento
LG210548
- G43 Tortora
LG210543
- G39 Bianco Soft
LG210539
- G68 Bianco
LG210568

Time WORKSTATION

Time 102 **new**

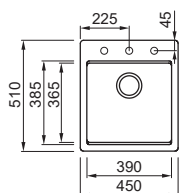
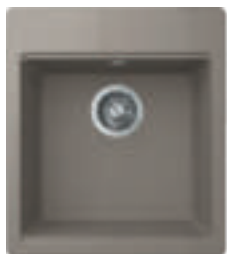

LAVELLO 1 VASCA

Dimensioni	450 x 510 mm
Base	450 500mm se inizio composizione
Foro da incasso	430 x 480 mm
Profondità vasca	180 mm
Banco rubinetteria	Si
Installazione	Sopratop

GRANITEK

€ 400

- G40** Nero LG210240
- G78** Espresso LG210278
- G48** Cemento LG210248
- G43** Tortora LG210243
- G39** Bianco Soft LG210239
- G68** Bianco LG210268

Accessori consigliati



DRAINER FLEX 440

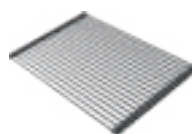

- BK Black ARS013BK € 80
- GR Grey ARS013GR € 80

BOWL 380



- BK Black ABP038BK € 65
- GR Grey ABP038GR € 65



CHOPPING BOARD 380



- BK Black ATH143BK € 90
- WD Wood ATH143WD € 90

COLANDER 380



- BK Black AVP038BK € 65
- GR Grey AVP038GR € 65

Time WORKSTATION

Time 130 Total black **new**

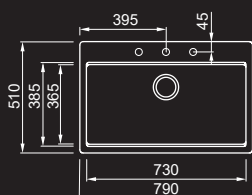
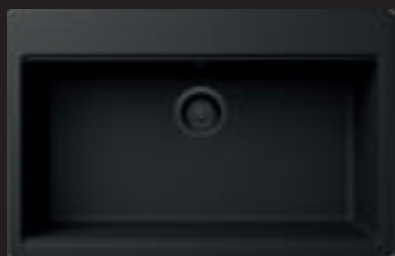

LAVELLO 1 VASCA

Dimensioni	790 x 510 mm
Base	800 mm
Foro da incasso	770 x 480 mm
Profondità vasca	180 mm
Banco rubinetteria	Si
Installazione	Sopratop

GRANITEK

€ 490

G40 Nero
LG213040BKBM

Time 105 Total black **new**

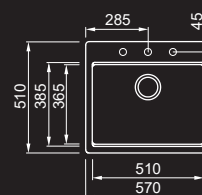

LAVELLO 1 VASCA

Dimensioni	570 x 510 mm
Base	600 mm
Foro da incasso	550 x 480 mm
Profondità vasca	180 mm
Banco rubinetteria	Si
Installazione	Sopratop

GRANITEK

€ 450

G40 Nero
LG210540BKBM

Time

WORKSTATION

Time 102 Totalblack

new

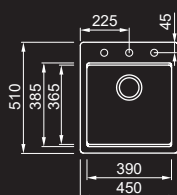
**LAVELLO 1 VASCA**

Dimensioni	450 x 510 mm
Base	450 500 mm se inizio composizione
Foro da incasso	430 x 480 mm
Profondità vasca	180 mm
Banco rubinetteria	Si
Installazione	Sopratop

GRANITEK

€ 430

G40

Nero
LG210240BKM

Time WORKSTATION

IDEE DI STILE

Ventum PURE new

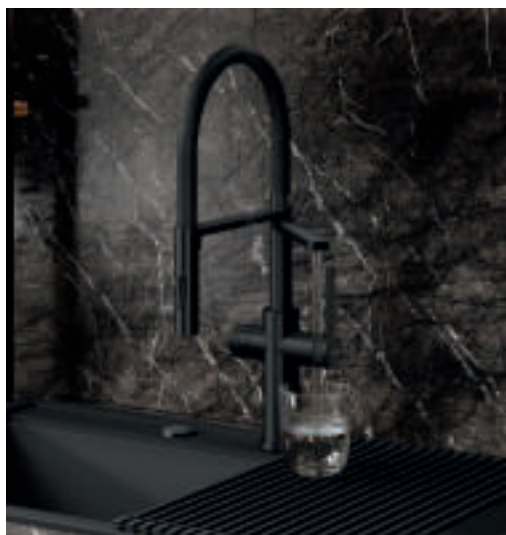

Caratteristiche tecniche ed altre finiture a pag. 181

ELLECI PURE
AFICAMGR € 350



BK Black
MOKVNTBK € 440

DRAIN SYSTEM

FLOW SYSTEM



BK Black
KITWPT-FB-1VTELL-BK € 35
IN Inox
KITWPT-FB-1VTELL-IN € 30

TUTTI I MODELLI

FLOW OPEN UP



BK Black
KITASP-FB-1VTELL-BK € 80
IN Inox
KITASP-FB-1VTELL-IN € 70

TUTTI I MODELLI

FLOW OPEN TWIST



BK Black
KITASPT-FB-1VTELL-BK € 80
IN Inox
KITASPT-FB-1VTELL-IN € 70

TUTTI I MODELLI

ELLECI ZERO



Serie 60
TDZ060GR € 380
Serie 100
TDZ100GR € 450

TUTTI I MODELLI

COMPATIBILITÀ ACCESSORI LAVELLO

CHOPPING BOARD
380



BK Black
ATH143BK € 90
WD Wood
ATH143WD € 90

TUTTI I MODELLI

DRAINER FLEX
440

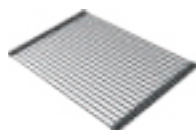

BK Black
ARS013BK € 80
GR Grey
ARS013GR € 80

TUTTI I MODELLI

COLANDER
380

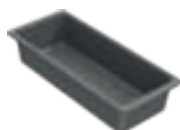

BK Black
AVP038BK € 65
GR Grey
AVP038GR € 65

TUTTI I MODELLI

BOWL
380



BK Black
ABP038BK € 65
GR Grey
ABP038GR € 65

TUTTI I MODELLI

SOAP DISPENSER
TONDO



BK Black
ADI02304BK € 70
GM Gun metal
ADI02304GM € 70
CR Cromo
ADI02304CR € 60

TUTTI I MODELLI

SOAP DISPENSER
QUADRATO



CR Cromo
ADI02301 € 100

TUTTI I MODELLI

POD
250



BK Black
APS250BK € 80
GR Grey
APS250GR € 80

Time

WORKSTATION

NEW
COLLECTION

Lavello Time 105 - G40 Nero
Miscelatore Danubio - G40 Nero



Time undermount WORKSTATION

La collezione Time undermount si declina in una duplice installazione: sottotop, precisa ed elegante, o classica sopratop. Il sistema di scarico è nascosto dalla cover per preservare l'armonia estetica all'interno della vasca o costruire contrasti di colore.

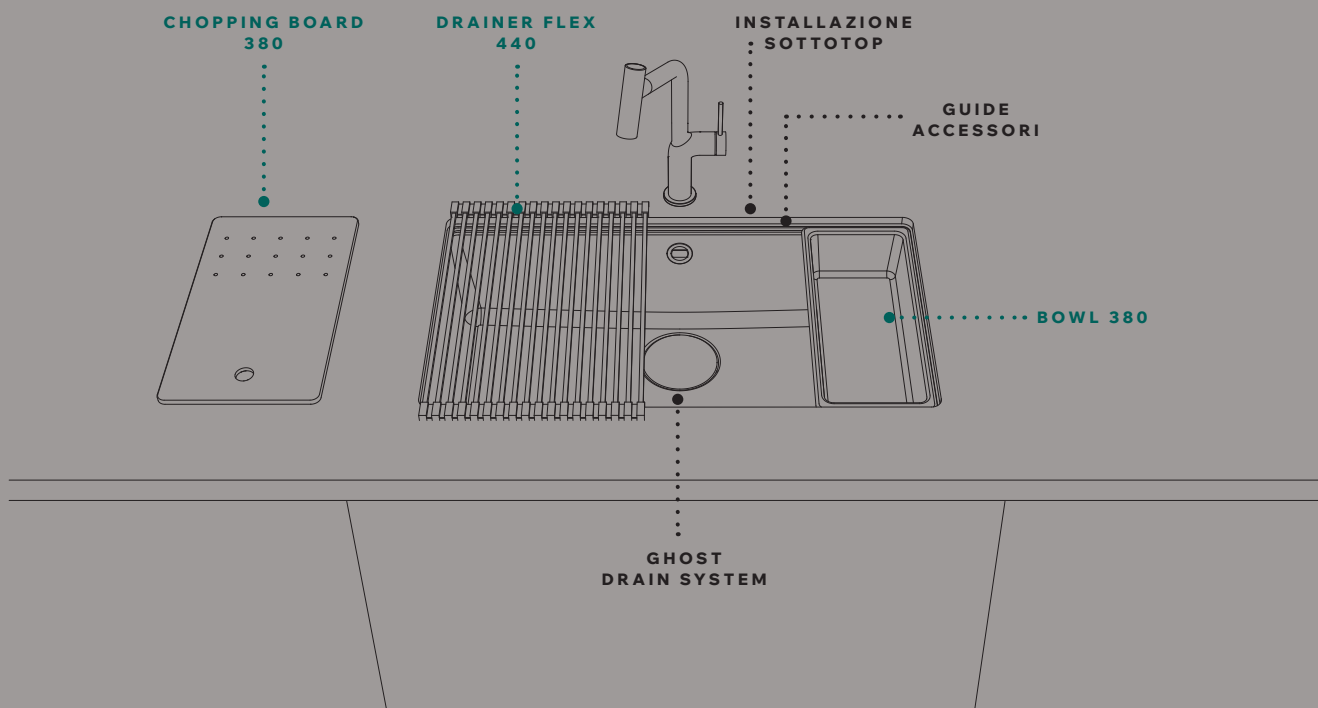

MODELLI TIME UNDERMOUNT WORKSTATION

new



Time undermount 130

new



Time undermount 105

NEW
COLLECTION



Lavello Time undermount 130 - G40 Nero
Miscelatore Loch - BK Black

GRANITEK

- G40 NERO
- G78 ESPRESSO
- G48 CEMENTO
- G43 TORTORA
- G39 BIANCO SOFT
- G68 BIANCO

Time undermount WORKSTATION

Time undermount 130 **new**

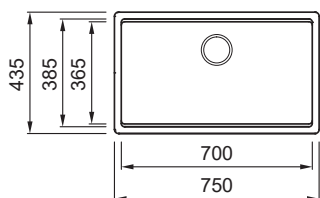

LAVELLO 1 VASCA

Dimensioni	750 x 435 mm
Base	800 mm
Foro da incasso	700 x 385 mm R12 (sottotop)
Foro da incasso	740 x 425 mm R5 (sopratop)
Profondità vasca	180 mm
Banco rubinetteria	No
Installazione	Sottotop / Sopratop

GRANITEK

€ 480

- G40** Nero LG213040BSO
- G78** Espresso LG213078BSO
- G48** Cemento LG213048BSO
- G43** Tortora LG213043BSO
- G39** Bianco Soft LG213039BSO
- G68** Bianco LG213068BSO

Time undermount 105 **new**

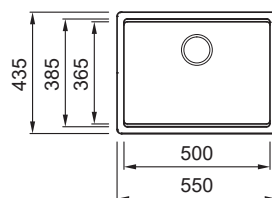

LAVELLO 1 VASCA

Dimensioni	550 x 435 mm
Base	600 mm
Foro da incasso	500 x 385 mm R12 (sottotop)
Foro da incasso	540 x 425 mm R5 (sopratop)
Profondità vasca	180 mm
Banco rubinetteria	No
Installazione	Sottotop / Sopratop

GRANITEK

€ 440

- G40** Nero LG210540BSO
- G78** Espresso LG210578BSO
- G48** Cemento LG210548BSO
- G43** Tortora LG210543BSO
- G39** Bianco Soft LG210539BSO
- G68** Bianco LG210568BSO

Time undermount WORKSTATION

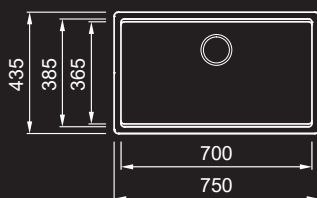
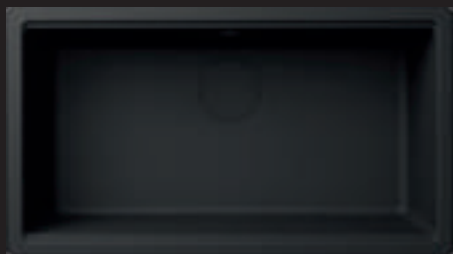
Time undermount 130 Total black **new****LAVELLO 1 VASCA**

Dimensioni	750 x 435 mm
Base	800 mm
Foro da incasso	700 x 385 mm R12 (sottotop)
Foro da incasso	740 x 425 mm R5 (sopratop)
Profondità vasca	180 mm
Banco rubinetteria	No
Installazione	Sottotop / Sopratop

GRANITEK

€ 510

G40

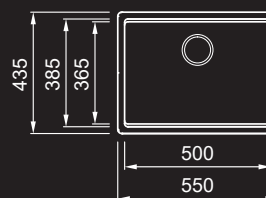
Nero
LG213040BSOBKMTime undermount 105 Total black **new****LAVELLO 1 VASCA**

Dimensioni	550 x 435 mm
Base	600 mm
Foro da incasso	500 x 385 mm R12 (sottotop)
Foro da incasso	540 x 425 mm R5 (sopratop)
Profondità vasca	180 mm
Banco rubinetteria	No
Installazione	Sottotop / Sopratop

GRANITEK

€ 470

G40

Nero
LG210540BSOBKM

Time undermount WORKSTATION

IDEE DI STILE

Loch new



Caratteristiche tecniche ed altre finiture a pag. 187

● BK Black
MOKLOCBK € 370

COMPATIBILITÀ ACCESSORI LAVELLO

CHOPPING BOARD 380



● BK Black
ATH143BK € 90
● WD Wood
ATH143WD € 90

TUTTI I MODELLI

DRAINER FLEX 440

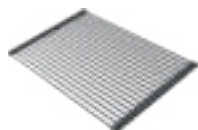

● BK Black
ARS013BK € 80
● GR Grey
ARS013GR € 80

TUTTI I MODELLI

COLANDER 380

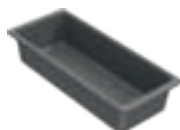

● BK Black
AVP038BK € 65
● GR Grey
AVP038GR € 65

TUTTI I MODELLI

BOWL 380

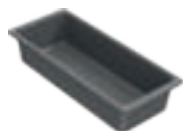

● BK Black
ABP038BK € 65
● GR Grey
ABP038GR € 65

TUTTI I MODELLI

POD 250



● BK Black
APS250BK € 80
● GR Grey
APS250GR € 80

TUTTI I MODELLI

DRAIN SYSTEM

GHOST SYSTEM



● BK Black
KITWPT-FBC-1VTELL-BK € 45
● IN Inox
KITWPT-FBC-1VTELL-IN € 40

TUTTI I MODELLI

GHOST SYSTEM OPEN UP



Nota:
installazione comando su top



● BK Black
KITASP-FBC-1VTELL-BK € 90
● IN Inox
KITASP-FBC-1VTELL-IN € 80

TUTTI I MODELLI

GHOST SYSTEM OPEN TWIST



Nota:
installazione comando su top



● BK Black
KITASPT-FBC-1VTELL-BK € 90
● IN Inox
KITASPT-FBC-1VTELL-IN € 80

TUTTI I MODELLI

ELLECI ZERO



Serie 60
TDZ060GR € 380
Serie 100
TDZ100GR € 450

TUTTI I MODELLI

Time undermount WORKSTATION

Lavello Time undermount 130 - G40 Nero
Miscelatore Loch - BK Black
Piano cottura - Urban 75 Glass
Forno - Urban Plus

**NEW
COLLECTION**



Zen

COLLECTION

Il fascino dell'essenzialità si esprime in geometrie perfette e nella simmetria degli elementi. Zen è la collezione di vasche premium, nata per evocare il senso dell'equilibrio e della raffinatezza contemporanea.

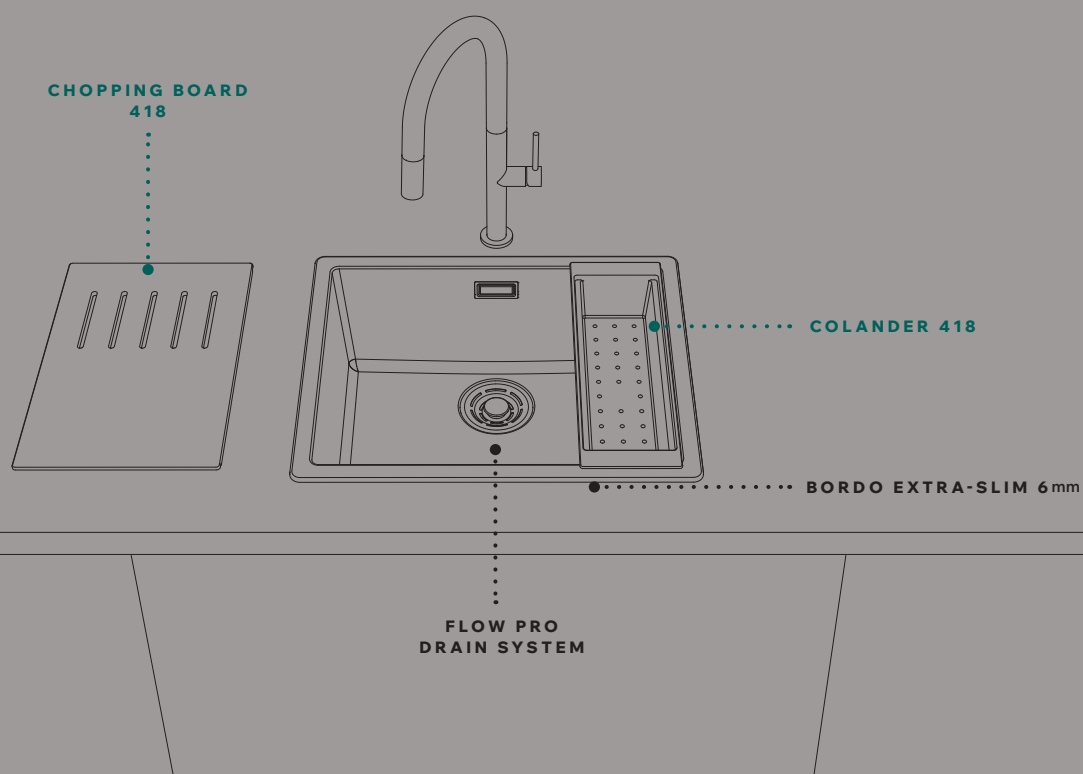

MODELLI ZEN



Zen 130

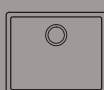

Zen 105



Zen 102



Zen 150

new



Lavello Zen 105 - K96 White
Miscelatore Kai - GM Gun metal

KERATEK



Zen COLLECTION

Zen 130

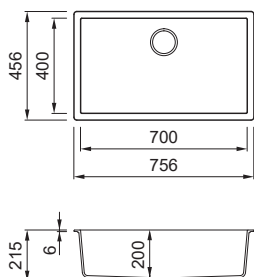

LAVELLO 1 VASCA

Dimensioni	756 x 456 mm
Base	800 mm
Foro da incasso	745 x 445 mm R5 (sopratop)
Foro da incasso	700x 400 mm R10 (sottotop)
Profondità vasca	200 mm
Banco rubinetteria	No
Installazione	Sopratop / Sottotop

KERATEK

€ 590

- K86 Black
LKZ13086
- K87 Cocoa
LKZ13087
- K99 Concrete
LKZ13099
- K89 Dove
LKZ13089
- K88 Cloud
LKZ13088
- K95 Champagne
LKZ13095
- K96 White
LKZ13096

Zen 105

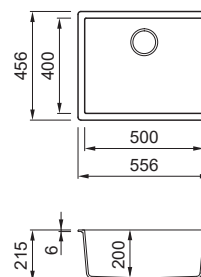

LAVELLO 1 VASCA

Dimensioni	556 x 456 mm
Base	600 mm
Foro da incasso	545 x 445 mm R5 (sopratop)
Foro da incasso	500x 400 mm R10 (sottotop)
Profondità vasca	200 mm
Banco rubinetteria	No
Installazione	Sopratop / Sottotop

KERATEK

€ 530

- K86 Black
LKZ10586
- K87 Cocoa
LKZ10587
- K99 Concrete
LKZ10599
- K89 Dove
LKZ10589
- K88 Cloud
LKZ10588
- K95 Champagne
LKZ10595
- K96 White
LKZ10596

Zen COLLECTION

Zen 102

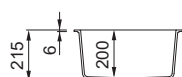
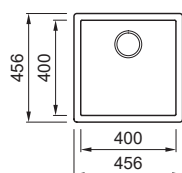

Zen 150 new

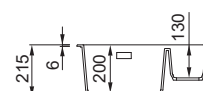
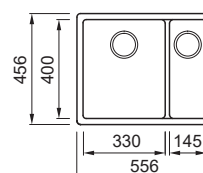

LAVELLO 1 VASCA

Dimensioni	456 x 456 mm
Base	450 500 mm se inizio composizione
Foro da incasso	445 x 445 mm R5 (sopratop)
Foro da incasso	400x 400 mm R10 (sottotop)
Profondità vasca	200 mm
Banco rubinetteria	No
Installazione	Sopratop / Sottotop

KERATEK

€ 500

- K86 Black LKZ10286
- K87 Cocoa LKZ10287
- K99 Concrete LKZ10299
- K89 Dove LKZ10289
- K88 Cloud LKZ10288
- K95 Champagne LKZ10295
- K96 White LKZ10296

LAVELLO 2 VASCHE

Dimensioni	556 x 456 mm
Base	600 mm
Foro da incasso	545 x 445 mm R5 (sopratop)
Foro da incasso	500x 400 mm R10 (sottotop)
Profondità vasca	200 mm e 130 mm
Banco rubinetteria	No
Installazione	Sopratop /Sottotop

KERATEK

€ 630

- K86 Black LKZ15086
- K87 Cocoa LKZ15087
- K99 Concrete LKZ15099
- K89 Dove LKZ15089
- K88 Cloud LKZ15088
- K95 Champagne LKZ15095
- K96 White LKZ15096

Zen COLLECTION

IDEE DI STILE

Kai new



Caratteristiche tecniche ed altre finiture a pag. 186

● GM Gun metal
MOKKAIGM € 360

DRAIN SYSTEM

FLOW PRO SYSTEM



● BK Black
KITWPT-F-1VSELL-BK € 115
● GM Gun metal
KITWPT-F-1VSELL-GM € 100
● IN Inox
KITWPT-F-1VSELL-IN € 50

TUTTI I MODELLI

ELLECI ZERO



Serie 60
TDZ060GR € 380
Serie 100
TDZ100GR € 450

TUTTI I MODELLI

COMPATIBILITÀ ACCESSORI LAVELLO

CHOPPING BOARD 418



● BK Black
ATH043BK € 110
● WD Wood
ATH043WD € 110

DRAINER FLEX 440

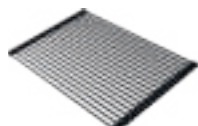

● BK Black
ARS013BK € 80
● GR Grey
ARS013GR € 80

COLANDER 418



● BK Black
AVP035BK € 65

TUTTI I MODELLI

TUTTI I MODELLI

TUTTI I MODELLI

POD 250



● BK Black
APS250BK € 80
● GR Grey
APS250GR € 80

Zen

COLLECTION

Lavello Zen 105 - K96 White
Miscelatore Kai - GM Gun metal



Zen F

COLLECTION

L'installazione filotop esalta il design puro ed essenziale della vasca, realizzando un'impeccabile continuità con il piano. Zen F è sinonimo di bellezza senza interruzioni, garanzia di precisione, armonia e leggerezza.

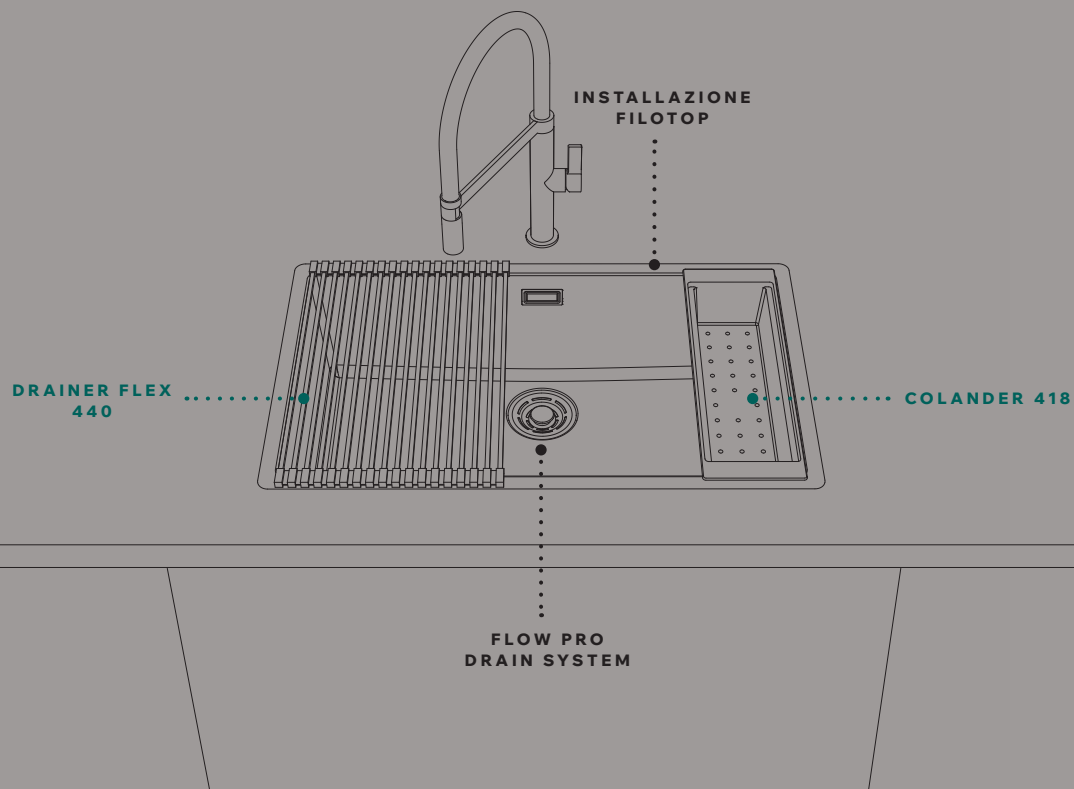

MODELLI ZEN F



Zen F 130

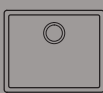

Zen F 105



Zen F 102

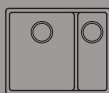

Zen F 150

new



Lavello Zen F 130 - K87 Cocoa
Miscelatore Wave - BK Black

KERATEK

K86
BLACK

K87
COCOA

K99
CONCRETE

K89
DOVE

K88
CLOUD

K95
CHAMPAGNE

K96
WHITE

Zen F COLLECTION

Zen F 130

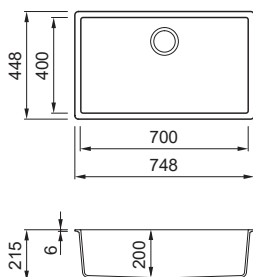

LAVELLO 1 VASCA

Dimensioni	748x 448 mm
Base	800 mm
Foro da incasso	Vedi disegno sotto
Profondità vasca	200 mm
Banco rubinetteria	No
Installazione	Filotop

KERATEK

€ 630

- K86** Black LKZ13086F01
- K87** Cocoa LKZ13087F01
- K99** Concrete LKZ13099F01
- K89** Dove LKZ13089F01
- K88** Cloud LKZ13088F01
- K95** Champagne LKZ13095F01
- K96** White LKZ13096F01

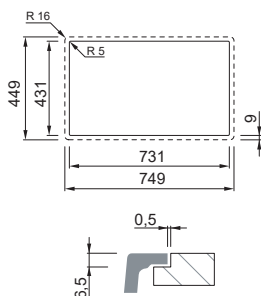

Zen F 105

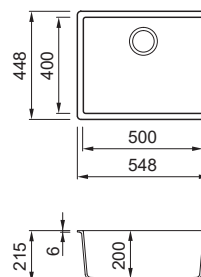

LAVELLO 1 VASCA

Dimensioni	548x 448 mm
Base	600 mm
Foro da incasso	Vedi disegno sotto
Profondità vasca	200 mm
Banco rubinetteria	No
Installazione	Filotop

KERATEK

€ 570

- K86** Black LKZ10586F01
- K87** Cocoa LKZ10587F01
- K99** Concrete LKZ10599F01
- K89** Dove LKZ10589F01
- K88** Cloud LKZ10588F01
- K95** Champagne LKZ10595F01
- K96** White LKZ10596F01

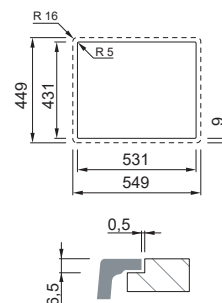

ZenF COLLECTION

ZenF 102

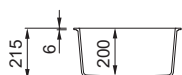
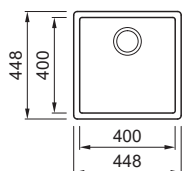

ZenF 150 new

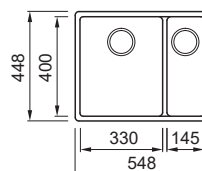

LAVELLO 1 VASCA

Dimensioni	448x 448 mm
Base	500 mm
Foro da incasso	Vedi disegno sotto
Profondità vasca	200 mm
Banco rubinetteria	No
Installazione	Filotop

LAVELLO 2 VASCHE

Dimensioni	548x 448 mm
Base	600 mm
Foro da incasso	Vedi disegno sotto
Profondità vasca	200 mm e 130 mm
Banco rubinetteria	No
Installazione	Filotop

KERATEK

€ 540

- K86 Black LKZ10286F01
- K87 Cocoa LKZ10287F01
- K99 Concrete LKZ10299F01
- K89 Dove LKZ10289F01
- K88 Cloud LKZ10288F01
- K95 Champagne LKZ10295F01
- K96 White LKZ10296F01

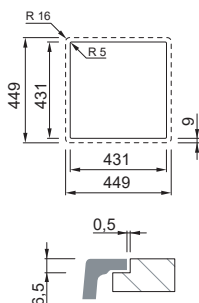

KERATEK

€ 670

- K86 Black LKZ15086F01
- K87 Cocoa LKZ15087F01
- K99 Concrete LKZ15099F01
- K89 Dove LKZ15089F01
- K88 Cloud LKZ15088F01
- K95 Champagne LKZ15095F01
- K96 White LKZ15096F01

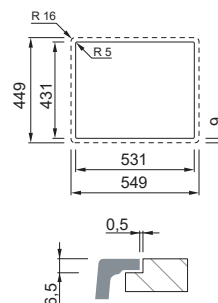

Zen F COLLECTION

IDEE DI STILE

Wave

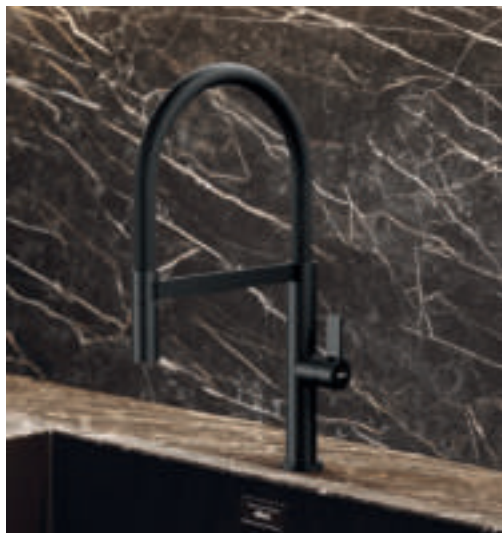

Caratteristiche tecniche ed altre finiture a pag. 185

● BK Black
MOKWAVBK € 360

COMPATIBILITÀ ACCESSORI LAVELLO

CHOPPING BOARD
418



● BK Black
ATH043BK € 110
● WD Wood
ATH043WD € 110

TUTTI I MODELLI

DRAINER FLEX
440

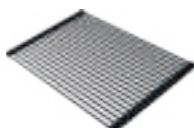

● BK Black
ARS013BK € 80
● GR Grey
ARS013GR € 80

TUTTI I MODELLI

COLANDER
418



● BK Black
AVP035BK € 65

TUTTI I MODELLI

POD 250



● BK Black
APS250BK € 80
● GR Grey
APS250GR € 80

DRAIN SYSTEM

FLOW PRO SYSTEM



● BK Black
KITWPT-F-1VSELL-BK € 115
● GM Gun metal
KITWPT-F-1VSELL-GM € 100
● IN Inox
KITWPT-F-1VSELL-IN € 50

TUTTI I MODELLI

ELLECI ZERO



Serie 60
TDZ060GR € 380
Serie 100
TDZ100GR € 450

TUTTI I MODELLI

Zen F

COLLECTION

Lavello Zen F 130 - K87 Cocoa
Miscelatore Wave - BK Black



Karisma

COLLECTION

Armonia e razionalità caratterizzano Karisma, la collezione di vasche sopra e sottotop dalle geometrie decise e il bordo svasato per facilitare le attività di pulizia. L'originale Square Drain System dà ancor più carattere alla vasca.

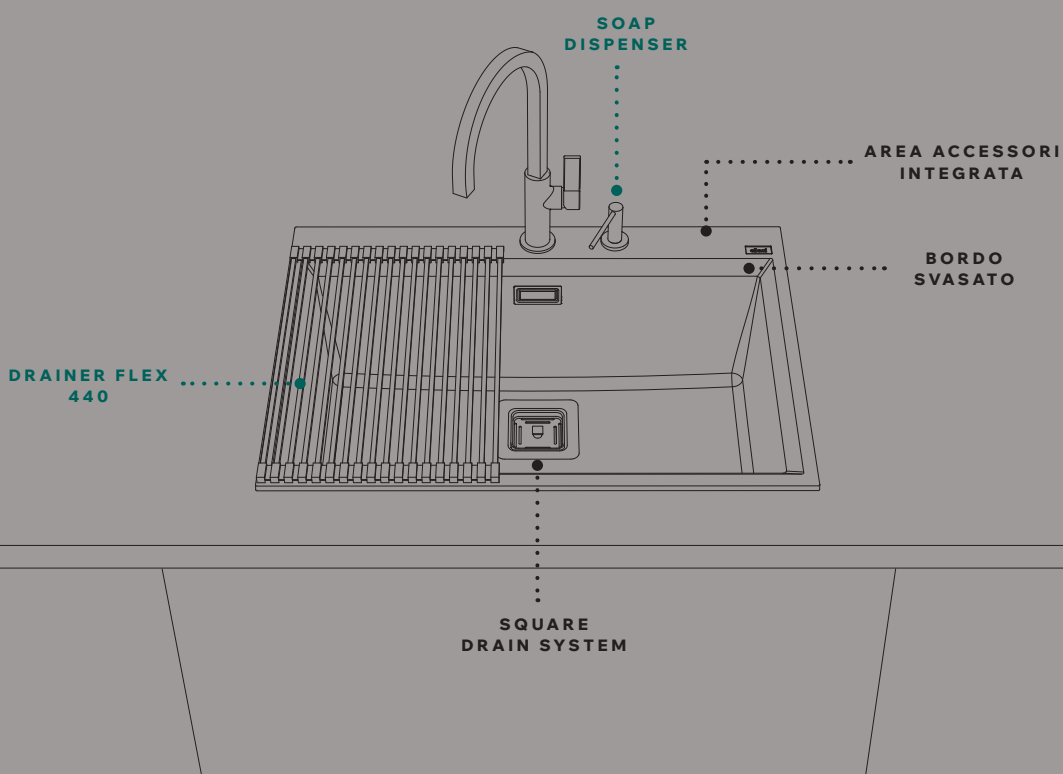

MODELLI KARISMA

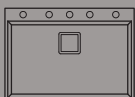

Karisma 120

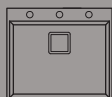

Karisma 105



Karisma 120
Sottotop



Karisma 105
Sottotop



Lavello Karisma 120 - G68 Bianco
Miscelatore Bridge - CR Cromo

GRANITEK

G40
NERO

G43
TORTORA

M79
NUVOLA

G68
BIANCO

Karisma COLLECTION

Karisma 120



base
75

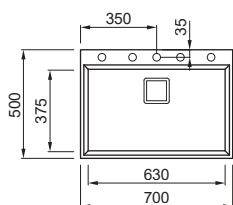

LAVELLO 1 VASCA

Dimensioni	700x500 mm
Base	750 mm
Foro da incasso	680 x 480 mm
Profondità vasca	220 mm
Banco rubinetteria	Si
Installazione	Sopratop

GRANITEK

€ 450

- G40 Nero LGK12040
- G43 Tortora LGK12043
- M79 Nuvola LMK12079
- G68 Bianco LGK12068

Karisma 105

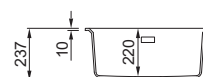
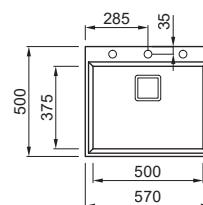

LAVELLO 1 VASCA

Dimensioni	570x500 mm
Base	600 mm
Foro da incasso	550 x 480 mm
Profondità vasca	220 mm
Banco rubinetteria	Si
Installazione	Sopratop

GRANITEK

€ 360

- G40 Nero LGK10540
- G43 Tortora LGK10543
- M79 Nuvola LMK10579
- G68 Bianco LGK10568

Karisma COLLECTION

Karisma 120 Sottotop

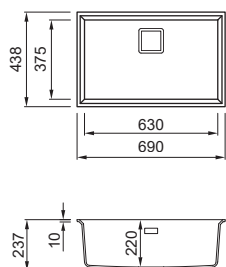

LAVELLO 1 VASCA

Dimensioni	690x 438 mm
Base	750 mm
Foro da incasso	664 x 411 mm R5
Profondità vasca	220 mm
Banco rubinetteria	Si
Installazione	Sottotop

GRANITEK

€ 470

- G40 Nero
LGK12040BSO
- G43 Tortora
LGK12043BSO
- M79 Nuvola
LMK12079BSO
- G68 Bianco
LGK12068BSO

Karisma 105 Sottotop

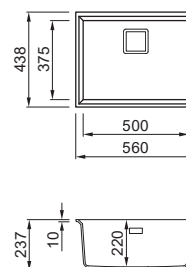

LAVELLO 1 VASCA

Dimensioni	560x 438 mm
Base	600 mm
Foro da incasso	534 x 411 mm R5
Profondità vasca	220 mm
Banco rubinetteria	Si
Installazione	Sottotop

GRANITEK

€ 380

- G40 Nero
LGK10540BSO
- G43 Tortora
LGK10543BSO
- M79 Nuvola
LMK10579BSO
- G68 Bianco
LGK10568BSO

Karisma COLLECTION

IDEE DI STILE

Bridge new design



Caratteristiche tecniche ed altre finiture a pag. 193

● G40 Nero MGKBRI40 € 280

COMPATIBILITÀ ACCESSORI LAVELLO

CHOPPING BOARD SLIDING 50



● BK Black ATH010BK € 130
● QU Quercia ATH010QU € 130

DRAINER FLEX 440

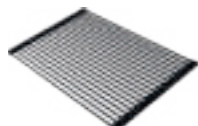

● BK Black ARS013BK € 80
● GR Grey ARS013GR € 80

SOLO KARISMA 120 E 105

TUTTI I MODELLI

SOAP DISPENSER TONDO



● BK Black ADI02304BK € 70
● GM Gun metal ADI02304GM € 70
● CR Cromo ADI02304CR € 60

SOAP DISPENSER QUADRATO



● CR Cromo ADI02301 € 100

SOLO KARISMA 120 E 105

SOLO KARISMA 120 E 105

POD 250



● BK Black APS250BK € 80
● GR Grey APS250GR € 80

DRAIN SYSTEM

SQUARE OPEN UP



● IN Inox KITASP-Q-1VSELL-IN € 70

SOLO KARISMA 120 E 105

ELLECI ZERO



Serie 60 TDZ060GR € 380
Serie 100 TDZ100GR € 450

TUTTI I MODELLI

FLANGIA DISSIPATORE PILETTA QUADRATA



ATQ01300 € 38

Nota:
Accessorio necessario per l'installazione del dissipatore con tutti i lavelli Karisma

Karisma

COLLECTION

Lavello Karisma 120 - G68 Bianco
Miscelatore Bridge - CR Cromo
Piano cottura Urban 80 Induction - BK Black
Forno Urban Plus - BK Black
Microonde Urban - BK Black



Quadra COLLECTION

Quadra combina semplicità e carattere moderno. La vasca dalle linee squadrate è disponibile in numerosi modelli e colori per un look contemporaneo e un'esperienza di utilizzo pratica e confortevole.

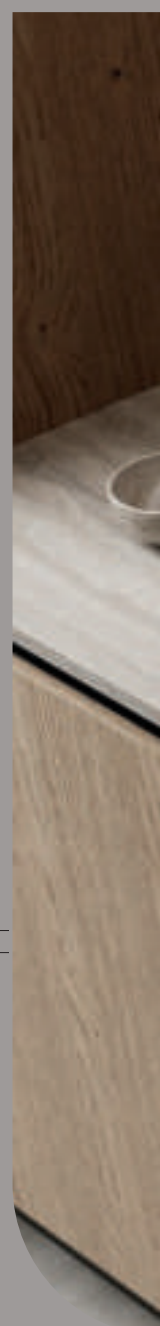
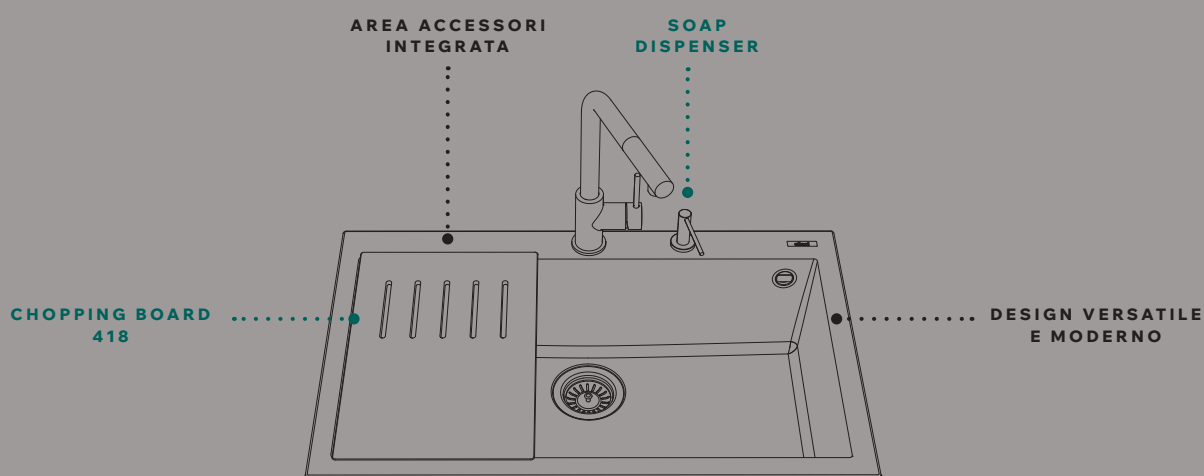

MODELLI QUARDA

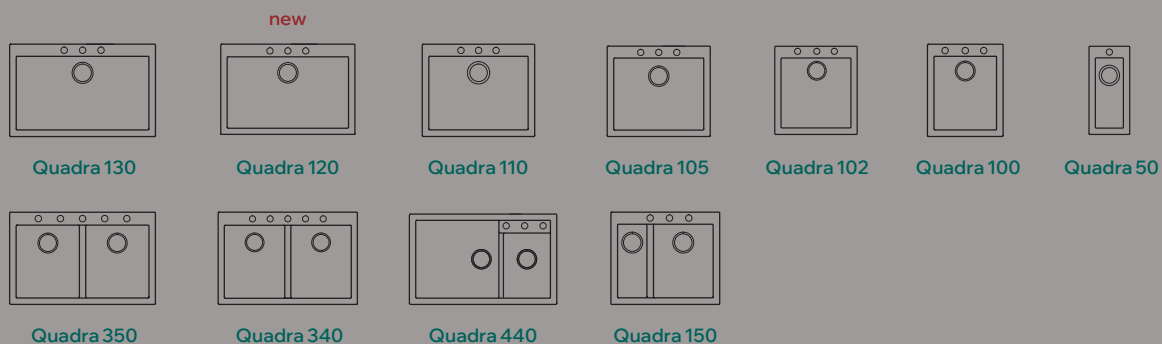



Lavello Quadra 130 - G43 Tortora
Miscelatore TrailPlus - G43 Tortora

GRANITEK



KERATEK



Quadra COLLECTION

Quadra 130

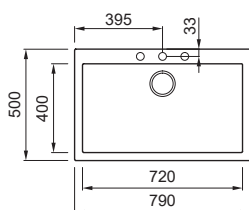

Quadra 120 **new**



base
75

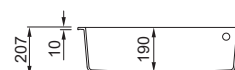
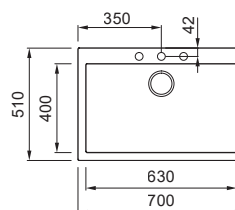

LAVELLO 1 VASCA

Dimensioni	790 x 500 mm
Base	800 mm
Foro da incasso	770 x 480 mm
Profondità vasca	200 mm
Banco rubinetteria	Si
Installazione	Sopratop

LAVELLO 1 VASCA

Dimensioni	700 x 510 mm
Base	750 mm
Foro da incasso	680 x 480 mm
Profondità vasca	190 mm
Banco rubinetteria	Si
Installazione	Sopratop

GRANITEK

€ 400

- G40** Nero LGQ13040
- G78** Espresso LGQ13078
- G48** Cemento LGQ13048
- G43** Tortora LGQ13043
- M79** Nuvola LMQ13079
- G39** Bianco Soft LGQ13039
- G68** Bianco LGQ13068
- G59** Antracite LGQ13059
- G51** Avena LGQ13051
- G62** Bianco Antico LGQ13062

KERATEK

€ 520

- K86** Black LKQ13086
- K87** Cocoa LKQ13087
- K99** Concrete LKQ13099
- K89** Dove LKQ13089
- K88** Cloud LKQ13088
- K95** Champagne LKQ13095
- K96** White LKQ13096

GRANITEK

€ 380

- G40** Nero LGQ12040
- G48** Cemento LGQ12048
- G43** Tortora LGQ12043
- G68** Bianco LGQ12068

Quadra COLLECTION

Quadra 110

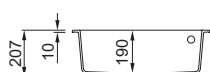
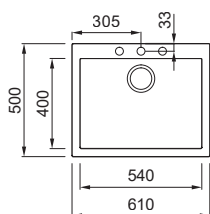

Quadra 105

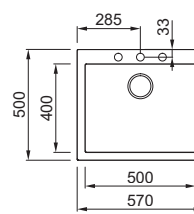

LAVELLO 1 VASCA

Dimensioni	610 x 500 mm
Base	600 750 mm se inizio composizione
Foro da incasso	590 x 480 mm
Profondità vasca	190 mm
Banco rubinetteria	Si
Installazione	Sopratop

LAVELLO 1 VASCA

Dimensioni	570 x 500 mm
Base	600 mm
Foro da incasso	550 x 480 mm
Profondità vasca	200 mm
Banco rubinetteria	Si
Installazione	Sopratop

GRANITEK

€ 360

G40	Nero LGQ11040
G78	Espresso LGQ11078
G48	Cemento LGQ11048
G43	Tortora LGQ11043
M79	Nuvola LMQ11079
G39	Bianco Soft LGQ11039
G68	Bianco LGQ11068
G59	Antracite LGQ11059
G51	Avena LGQ11051
G62	Bianco Antico LGQ11062

KERATEK

€ 470

K86	Black LKQ11086
K87	Cocoa LKQ11087
K99	Concrete LKQ11099
K89	Dove LKQ11089
K88	Cloud LKQ11088
K95	Champagne LKQ11095
K96	White LKQ11096

GRANITEK

€ 360

G40	Nero LGQ10540
G78	Espresso LGQ10578
G48	Cemento LGQ10548
G43	Tortora LGQ10543
M79	Nuvola LMQ10579
G39	Bianco Soft LGQ10539
G68	Bianco LGQ10568
G59	Antracite LGQ10559
G51	Avena LGQ10551
G62	Bianco Antico LGQ10562

KERATEK

€ 470

K86	Black LKQ10586
K87	Cocoa LKQ10587
K99	Concrete LKQ10599
K89	Dove LKQ10589
K88	Cloud LKQ10588
K95	Champagne LKQ10595
K96	White LKQ10596

Quadra COLLECTION

Quadra 102

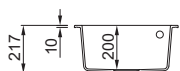
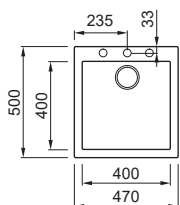
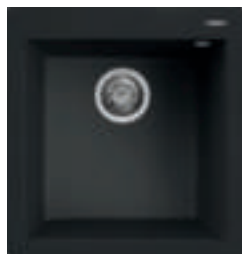

LAVELLO 1 VASCA

Dimensioni	470 x 500 mm
Base	450 500 mm se inizio composizione
Foro da incasso	450 x 480 mm
Profondità vasca	200 mm
Banco rubinetteria	Si
Installazione	Sopratop

GRANITEK

€ 360

- G40** Nero LGQ10240
- G78** Espresso LGQ10278
- G48** Cemento LGQ10248
- G43** Tortora LGQ10243
- M79** Nuvola LMQ10279
- G39** Bianco Soft LGQ10239
- G68** Bianco LGQ10268
- G59** Antracite LGQ10259
- G51** Avena LGQ10251
- G62** Bianco Antico LGQ10262

KERATEK

€ 470

- K86** Black LKQ10286
- K87** Cocoa LKQ10287
- K99** Concrete LKQ10299
- K89** Dove LKQ10289
- K88** Cloud LKQ10288
- K95** Champagne LKQ10295
- K96** White LKQ10296

Quadra 100

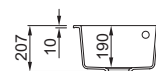
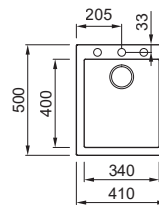

LAVELLO 1 VASCA

Dimensioni	410 x 500 mm
Base	450 mm
Foro da incasso	390 x 480 mm
Profondità vasca	190 mm
Banco rubinetteria	Si
Installazione	Sopratop

GRANITEK

€ 290

- G40** Nero LGQ10040
- G78** Espresso LGQ10078
- G48** Cemento LGQ10048
- G43** Tortora LGQ10043
- M79** Nuvola LMQ10079
- G39** Bianco Soft LGQ10039
- G68** Bianco LGQ10068
- G59** Antracite LGQ10059
- G51** Avena LGQ10051
- G62** Bianco Antico LGQ10062

KERATEK

€ 380

- K86** Black LKQ10086
- K87** Cocoa LKQ10087
- K99** Concrete LKQ10099
- K89** Dove LKQ10089
- K88** Cloud LKQ10088
- K95** Champagne LKQ10095
- K96** White LKQ10096

Quadra

COLLECTION

Quadra 50

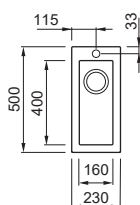

LAVELLO 1 VASCA

Dimensioni	230 x 500 mm
Base	300 mm
Foro da incasso	215 x 480 mm
Profondità vasca	155 mm
Banco rubinetteria	Si
Installazione	Sopratop

GRANITEK

€ 240

G40 Nero
LGQ05040

G48 Cemento
LGQ05048

G43 Tortora
LGQ05043

G68 Bianco
LGQ05068

Quadra COLLECTION

Quadra 350

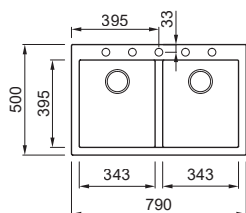

LAVELLO 2 VASCHE

Dimensioni	790 x 500 mm
Base	800 mm
Foro da incasso	770 x 480 mm
Profondità vasca	210 mm
Banco rubinetteria	Si
Installazione	Sopratop

GRANITEK

€ 450

- G40** Nero LGQ35040
- G78** Espresso LGQ35078
- G48** Cemento LGQ35048
- G43** Tortora LGQ35043
- M79** Nuvola LMQ35079
- G39** Bianco Soft LGQ35039
- G68** Bianco LGQ35068
- G59** Antracite LGQ35059
- G51** Avena LGQ35051
- G62** Bianco Antico LGQ35062

KERATEK

€ 600

- K86** Black LKQ35086
- K87** Cocoa LKQ35087
- K99** Concrete LKQ35099
- K89** Dove LKQ35089
- K88** Cloud LKQ35088
- K95** Champagne LKQ35095
- K96** White LKQ35096

Quadra 340

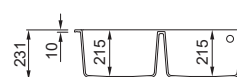
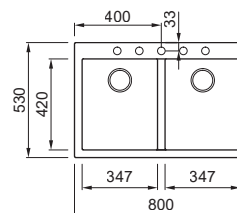

LAVELLO 2 VASCHE

Dimensioni	800 x 530 mm
Base	800 900 mm se inizio composizione
Foro da incasso	780 x 510 mm
Profondità vasca	215 mm
Banco rubinetteria	Si
Installazione	Sopratop

GRANITEK

€ 500

- G40** Nero LGQ34040BTP
- G48** Cemento LGQ34048BTP
- G43** Tortora LGQ34043BTP
- G68** Bianco LGQ34068BTP

Quadra COLLECTION

Quadra 440

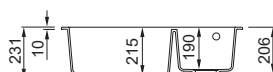
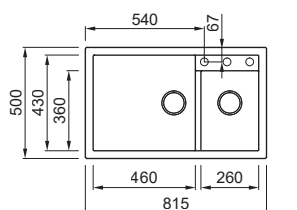
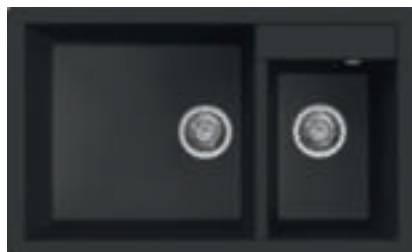

LAVELLO 2 VASCHE

Dimensioni	815 x 500 mm
Base	800 900 mm se inizio composizione
Foro da incasso	800 x 480 mm
Profondità vasca	215 mm e 190 mm
Banco rubinetteria	Si
Installazione	Sopratop

GRANITEK

€ 530

- G40 Nero
LGQ44040
- G48 Cemento
LGQ44048
- G43 Tortora
LGQ44043
- G68 Bianco
LGQ44068

Quadra 150

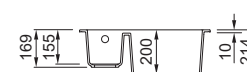
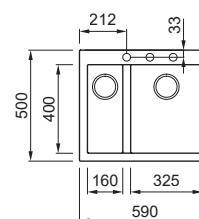
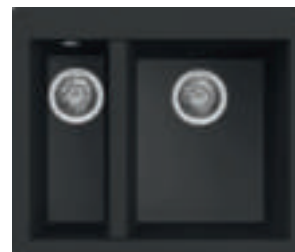

LAVELLO 2 VASCHE

Dimensioni	590 x 500 mm
Base	600 mm
Foro da incasso	570 x 480 mm
Profondità vasca	200 mm e 155 mm
Banco rubinetteria	Si
Installazione	Sopratop

GRANITEK

€ 400

- G40 Nero
LGQ15040
- G48 Cemento
LGQ15048
- G43 Tortora
LGQ15043
- G68 Bianco
LGQ15068

Quadra COLLECTION

IDEE DI STILE

Trail Plus



● G 43 Tortora
MGKTRP43 € 320

Caratteristiche tecniche ed altre finiture a pag. 188

DRAIN SYSTEM

BASE OPEN UP



● IN Inox
KITASP-A-1VTELL-IN € 45
● BK Black
KITASP-A-1VTELL-BK € 90

TUTTI I MODELLI TRANNE QUADRA 50

ELLECI ZERO



Serie 60
TDZ060GR € 380
Serie 100
TDZ100GR € 450

TUTTI I MODELLI TRANNE QUADRA 50

COMPATIBILITÀ ACCESSORI LAVELLO

CHOPPING BOARD
418



● BK Black
ATH043BK € 110
● WD Wood
ATH043WD € 110

DRAINER FLEX
440

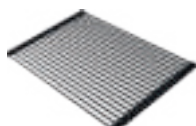

● BK Black
ARS013BK € 80
● GR Grey
ARS013GR € 80

MODELLI 130,120,110,105,102,100,350,150

MODELLI 130,120,110,350,150

COLANDER
418



● BK Black
AVP035BK € 65

SOAP DISPENSER
TONDO



● BK Black
ADI02304BK € 70
● GM Gun metal
ADI02304GM € 70
● CR Cromo
ADI02304CR € 60

SOAP DISPENSER
QUADRATO



● CR Cromo
ADI02301 € 100

MODELLI 130,120,110,105,102,100,350,150

TUTTI I MODELLI TRANNE 50

POD 250



● BK Black
APS250BK € 80
● GR Grey
APS250GR € 80

Quadra COLLECTION

Lavello Quadra 130 - G43 Tortora
Miscelatore Trail Plus - G40 Nero
Piano cottura Plano 75 - G43 Tortora
Forno Plano - G43 Tortora
Microonde Plano - G43 Tortora
Cappa Brio - BK Black









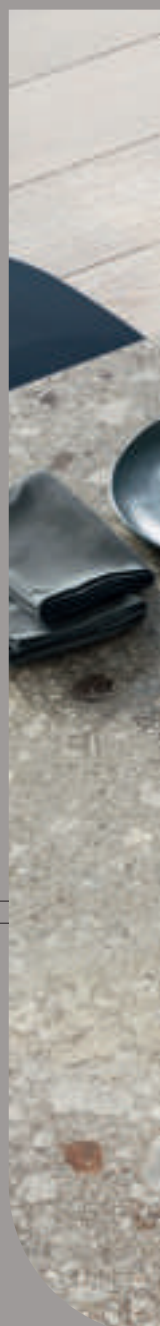
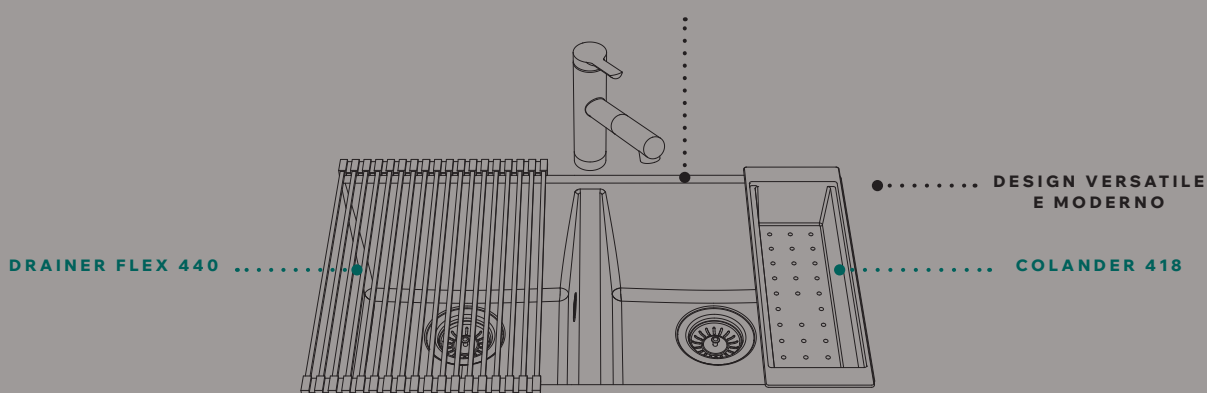



Quadra SOTTOTOP

La collezione Quadra con installazione sottotop valorizza l'incontro con il piano di lavoro, creando una continuità estetica e funzionale che esalta il design della cucina e facilita la pulizia.

INSTALLAZIONE SOTTOTOP

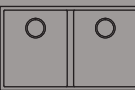

MODELLI QUADRA SOTTOTOP

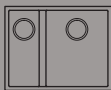
- | | | | | | | |
|---|---|---|---|--|---|---|
|  | new
 |  |  |  |  |  |
| Quadra 130
Sottotop | Quadra 120
Sottotop | Quadra 110
Sottotop | Quadra 105
Sottotop | Quadra 102
Sottotop | Quadra 100
Sottotop | Quadra 50
Sottotop |
|  |  |  |  | | | |
| Quadra 350
Sottotop | Quadra 340
Sottotop | Quadra 440
Sottotop | Quadra 150
Sottotop | | | |



Lavello Quadra 350 Sottotop - K99 Concrete
Miscelatore Taos - CR Cromo

GRANITEK



KERATEK



Quadra SOTTOTOP

Quadra 130 Sottotop

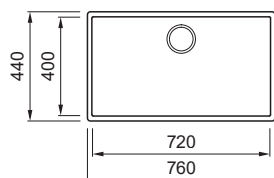

LAVELLO 1 VASCA

Dimensioni	760 x 440 mm
Base	800 mm
Foro da incasso	720 x 400 mm R 5
Profondità vasca	200 mm
Banco rubinetteria	No
Installazione	Sottotop

GRANITEK

€ 420

- G40** Nero LGQ13040BSO
- G78** Espresso LGQ13078BSO
- G48** Cemento LGQ13048BSO
- G43** Tortora LGQ13043BSO
- M79** Nuvola LMQ13079BSO
- G39** Bianco Soft LGQ13039BSO
- G68** Bianco LGQ13068BSO
- G59** Antracite LGQ13059BSO
- G51** Avena LGQ13051BSO
- G62** Bianco Antico LGQ13062BSO

KERATEK

€ 540

- K86** Black LKQ13086BSO
- K87** Cocoa LKQ13087BSO
- K99** Concrete LKQ13099BSO
- K89** Dove LKQ13089BSO
- K88** Cloud LKQ13088BSO
- K95** Champagne LKQ13095BSO
- K96** White LKQ13096BSO

Quadra 120 Sottotop new



base
75

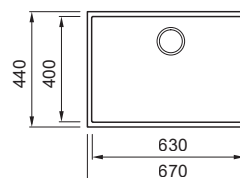

LAVELLO 1 VASCA

Dimensioni	670 x 440 mm
Base	750 mm
Foro da incasso	630 x 400 mm R 5
Profondità vasca	190 mm
Banco rubinetteria	No
Installazione	Sottotop

GRANITEK

€ 400

- G40** Nero LGQ12040BSO
- G48** Cemento LGQ12048BSO
- G43** Tortora LGQ12043BSO
- G68** Bianco LGQ12068BSO

Quadra SOTTOTOP

Quadra 110 Sottotop

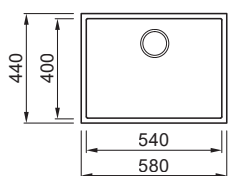

Quadra 105 Sottotop

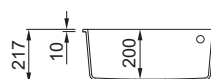
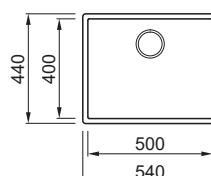

LAVELLO 1 VASCA

Dimensioni	580 x 440 mm
Base	750 mm
Foro da incasso	540 x 400 mm R 5
Profondità vasca	190 mm
Banco rubinetteria	No
Installazione	Sottotop

LAVELLO 1 VASCA

Dimensioni	540 x 440 mm
Base	600 mm
Foro da incasso	500 x 400 mm R 5
Profondità vasca	200 mm
Banco rubinetteria	No
Installazione	Sottotop

GRANITEK

€ 380

- G40** Nero LGQ11040BSO
- G78** Espresso LGQ11078BSO
- G48** Cemento LGQ11048BSO
- G43** Tortora LGQ11043BSO
- M79** Nuvola LMQ11079BSO
- G39** Bianco Soft LGQ11039BSO
- G68** Bianco LGQ11068BSO
- G59** Antracite LGQ11059BSO
- G51** Avena LGQ11051BSO
- G62** Bianco Antico LGQ11062BSO

KERATEK

€ 490

- K86** Black LKQ11086BSO
- K87** Cocoa LKQ11087BSO
- K99** Concrete LKQ11099BSO
- K89** Dove LKQ11089BSO
- K88** Cloud LKQ11088BSO
- K95** Champagne LKQ11095BSO
- K96** White LKQ11096BSO

GRANITEK

€ 380

- G40** Nero LGQ10540BSO
- G78** Espresso LGQ10578BSO
- G48** Cemento LGQ10548BSO
- G43** Tortora LGQ10543BSO
- M79** Nuvola LMQ10579BSO
- G39** Bianco Soft LGQ10539BSO
- G68** Bianco LGQ10568BSO
- G59** Antracite LGQ10559BSO
- G51** Avena LGQ10551BSO
- G62** Bianco Antico LGQ10562BSO

KERATEK

€ 490

- K86** Black LKQ10586BSO
- K87** Cocoa LKQ10587BSO
- K99** Concrete LKQ10599BSO
- K89** Dove LKQ10589BSO
- K88** Cloud LKQ10588BSO
- K95** Champagne LKQ10595BSO
- K96** White LKQ10596BSO

Quadra SOTTOTOP

Quadra 102 Sottotop

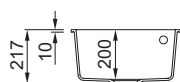
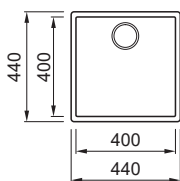

LAVELLO 1 VASCA

Dimensioni	440 x 440 mm
Base	500 mm
Foro da incasso	400 x 400 mm R5
Profondità vasca	200 mm
Banco rubinetteria	Si
Installazione	Sottotop

GRANITEK

€ 380

- G40** Nero LGQ10240BSO
- G78** Espresso LGQ10278BSO
- G48** Cemento LGQ10248BSO
- G43** Tortora LGQ10243BSO
- M79** Nuvola LMQ10279BSO
- G39** Bianco Soft LGQ10239BSO
- G68** Bianco LGQ10268BSO
- G59** Antracite LGQ10259BSO
- G51** Avena LGQ10251BSO
- G62** Bianco Antico LGQ10262BSO

KERATEK

€ 490

- K86** Black LKQ10286BSO
- K87** Cocoa LKQ10287BSO
- K99** Concrete LKQ10299BSO
- K89** Dove LKQ10289BSO
- K88** Cloud LKQ10288BSO
- K95** Champagne LKQ10295BSO
- K96** White LKQ10296BSO

Quadra 100 Sottotop

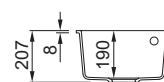
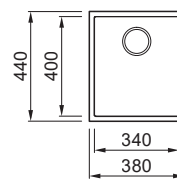

LAVELLO 1 VASCA

Dimensioni	380 x 440 mm
Base	450 mm
Foro da incasso	340 x 400 mm R5
Profondità vasca	190 mm
Banco rubinetteria	Si
Installazione	Sottotop

GRANITEK

€ 310

- G40** Nero LGQ10040BSO
- G78** Espresso LGQ10078BSO
- G48** Cemento LGQ10048BSO
- G43** Tortora LGQ10043BSO
- M79** Nuvola LMQ10079BSO
- G39** Bianco Soft LGQ10039BSO
- G68** Bianco LGQ10068BSO
- G59** Antracite LGQ10059BSO
- G51** Avena LGQ10051BSO
- G62** Bianco Antico LGQ10062BSO

KERATEK

€ 400

- K86** Black LKQ10086BSO
- K87** Cocoa LKQ10087BSO
- K99** Concrete LKQ10099BSO
- K89** Dove LKQ10089BSO
- K88** Cloud LKQ10088BSO
- K95** Champagne LKQ10095BSO
- K96** White LKQ10096BSO

Quadra SOTTOTOP

Quadra 50 Sottotop

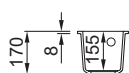
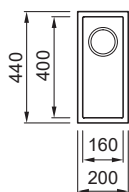

LAVELLO 1 VASCA

Dimensioni	200 x 440 mm
Base	300 mm
Foro da incasso	160 x 400 mm R5
Profondità vasca	155 mm
Banco rubinetteria	Si
Installazione	Sottotop

GRANITEK

€ 260

G40 Nero
LGQ05040BSO

G48 Cemento
LGQ05048BSO

G43 Tortora
LGQ05043BSO

G68 Bianco
LGQ05068BSO

Quadra SOTTOTOP

Quadra 350 Sottotop

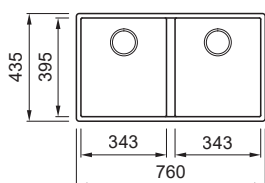

LAVELLO 2 VASCHE

Dimensioni	760 x 435 mm
Base	800 mm
Foro da incasso	720 x 395 mm R5
Profondità vasche	220 mm e 220 mm
Banco rubinetteria	No
Installazione	Sottotop

GRANITEK

€ 480

- G40** Nero LGQ35040BSO
- G78** Espresso LGQ35078BSO
- G48** Cemento LGQ35048BSO
- G43** Tortora LGQ35043BSO
- M79** Nuvola LMQ35079BSO
- G39** Bianco Soft LGQ35039BSO
- G68** Bianco LGQ35068BSO
- G59** Antracite LGQ35059BSO
- G51** Avena LGQ35051BSO
- G62** Bianco Antico LGQ35062BSO

KERATEK

€ 630

- K86** Black LKQ35086BSO
- K87** Cocoa LKQ35087BSO
- K99** Concrete LKQ35099BSO
- K89** Dove LKQ35089BSO
- K88** Cloud LKQ35088BSO
- K95** Champagne LKQ35095BSO
- K96** White LKQ35096BSO

Quadra 340 Sottotop

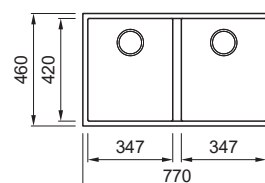

LAVELLO 2 VASCHE

Dimensioni	770 x 460 mm
Base	900 mm
Foro da incasso	730 x 420 mm R5
Profondità vasche	215 mm e 215 mm
Banco rubinetteria	No
Installazione	Sottotop

GRANITEK

€ 530

- G40** Nero LGQ34040BSC
- G48** Cemento LGQ34048BSC
- G43** Tortora LGQ34043BSC
- G68** Bianco LGQ34068BSC

Quadra SOTTOTOP

Quadra 440 Sottotop

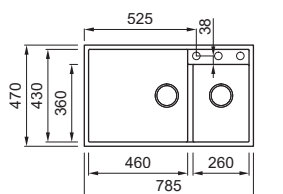

LAVELLO 2 VASCHE

Dimensioni	785 x 470 mm
Base	900 mm
Foro da incasso	745 x 430 mm R5
Profondità vasche	215 mm e 190 mm
Banco rubinetteria	Sì
Installazione	Sottotop

GRANITEK

€ 560

- G40** Nero LGQ44040BSO
- G48** Cemento LGQ44048BSO
- G43** Tortora LGQ44043BSO
- G68** Bianco LGQ44068BSO

Quadra 150 Sottotop

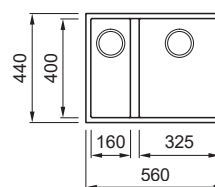

LAVELLO 2 VASCHE

Dimensioni	560 x 440 mm
Base	600 mm
Foro da incasso	520 x 400 mm R5
Profondità vasche	200 mm e 155 mm
Banco rubinetteria	No
Installazione	Sottotop

GRANITEK

€ 420

- G40** Nero LGQ15040BSO
- G48** Cemento LGQ15048BSO
- G43** Tortora LGQ15043BSO
- G68** Bianco LGQ15068BSO

Quadra SOTTOTOP

IDEE DI STILE

Taos new



Caratteristiche tecniche ed altre finiture a pag. 195

● CR Cromo
MIKTAOCR € 285

SMART AREA

ELLECI ZERO



Serie 60
TDZ060GR € 380
Serie 100
TDZ100GR € 450

TUTTI I MODELLI TRANNE QUADRA 50

COMPATIBILITÀ ACCESSORI LAVELLO

DRAINER FLEX 440

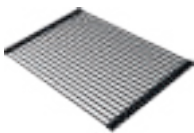

● BK Black
ARS013BK € 80
● GR Grey
ARS013GR € 80

COLANDER 418



● BK Black
AVP035BK € 65

MODELLI 130,120,110,350,150 MODELLI 130,120,110,105,102,100,350,150

POD 250



● BK Black
APS250BK € 80
● GR Grey
APS250GR € 80

Quadra SOTTOTOP

Lavello Quadra 350 Sottotop - K99 Concrete
Miscelatore Taos - CR Cromo



Fox

COLLECTION

Il restyling di Fox 360 rinnova l'iconica workstation e soddisfa il design contemporaneo. Dalle geometrie della vasca al tagliere personalizzato, ogni elemento è stato ripensato per offrire un'esperienza d'uso intuitiva e piacevole.

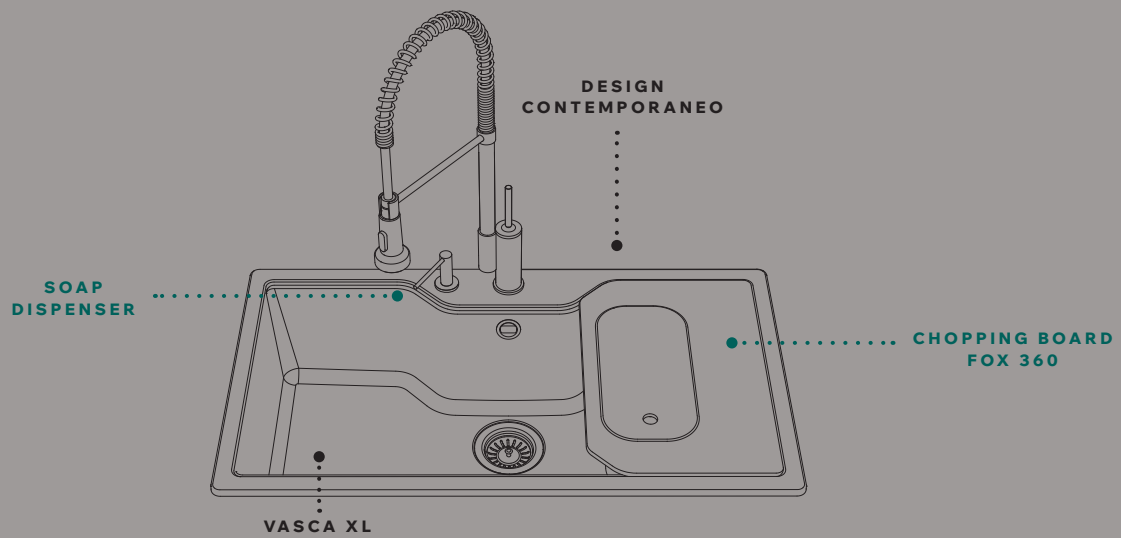

MODELLI FOX

new design

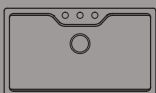

Fox 360



Fox 200



Fox Round

NEW
DESIGN



Lavello Fox 360 - M79 Nuvola
Miscelatore Chef - CR Cromo

GRANITEK

G40
NERO

M79
NUVOLA

G68
BIANCO

G59
ANTRACITE

G51
AVENA

G62
BIANCO
ANTICO

Fox COLLECTION

Fox 360 **new design**

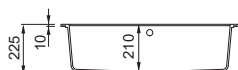
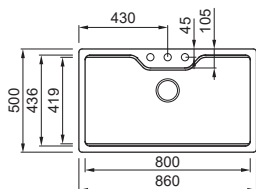

LAVELLO 1 VASCA

Dimensioni	860 x 500 mm
Base	900 mm
Foro da incasso	840 x 480 mm
Profondità vasca	210 mm
Banco rubinetteria	Si
Installazione	Sopratop
Orientamento	Non reversibile

GRANITEK

€ 420

G40 Nero LGF36040

M79 Nuvola LMF36079

G68 Bianco LGF36068

G62 Bianco Antico LGF36062

G59 Antracite LGF36059

G51 Avena LGF36051

Accessori consigliati



CHOPPING BOARD FOX 360



BK Black
ATH153BK € 120



CHOPPING BOARD FOX 360 (CON VASCETTA)



WD Wood
ATH153WD € 160

Fox COLLECTION

Fox 200

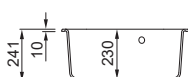
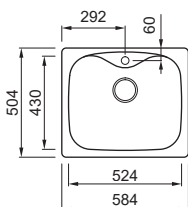

Fox Round

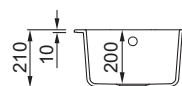
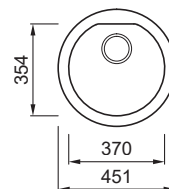

LAVELLO 1 VASCA

Dimensioni	584 x 504 mm
Base	600 mm
Foro da incasso	560 x 480 mm R32
Profondità vasca	230 mm
Banco rubinetteria	Si
Installazione	Sopratop
Orientamento	Non reversibile

GRANITEK

€ 370

- G40 Nero LGF20040
- M79 Nuvola LMF20079
- G68 Bianco LGF20068
- G62 Bianco Antico LGF20062
- G59 Antracite LGF20059
- G51 Avena LGF20051

LAVELLO 1 VASCA

Dimensioni	Ø 451 mm
Base	450 mm
Foro da incasso	Ø 430 mm
Profondità vasca	200 mm
Banco rubinetteria	Si
Installazione	Sopratop
Orientamento	Non reversibile

GRANITEK

€ 300

- G40 Nero LGFROU40
- M79 Nuvola LMFROU79
- G68 Bianco LGFROU68
- G62 Bianco Antico LGFROU62
- G59 Antracite LGFROU59
- G51 Avena LGFROU51

Fox COLLECTION

IDEE DI STILE

Chef new design



Caratteristiche tecniche ed altre finiture a pag. 184

● CR Cromo
MIKCHECR € 350

DRAIN SYSTEM

BASE OPEN UP



● IN Inox
KITASP-A-1VTELL-IN € 45
● BK Black
KITASP-A-1VTELL-BK € 90

SOLO CON FOX 360

ELLECI ZERO



Serie 60
TDZ060GR € 380
Serie 100
TDZ100GR € 450

COMPATIBILITÀ ACCESSORI LAVELLO

CHOPPING BOARD FOX 360



● BK Black
ATH153BK € 120

MODELLO FOX 360

CHOPPING BOARD FOX 360 (CON VASCHETTA)

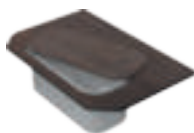

● WD Wood
ATH153WD € 160

MODELLO FOX 360

DRAINER FLEX 500

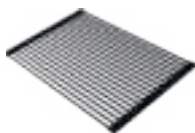

● BK Black
ARS023BK € 90
● GR Grey
ARS023GR € 90

MODELLO FOX 360

SOAP DISPENSER TONDO



● BK Black
ADI02304BK € 70
● GM Gun metal
ADI02304GM € 70
● CR Cromo
ADI02304CR € 60

MODELLO FOX 360

SOAP DISPENSER QUADRATO



● CR Cromo
ADI02301 € 100

MODELLO FOX 360

POD 250



● BK Black
APS250BK € 80
● GR Grey
APS250GR € 80

TUTTI I MODELLI

Fox

COLLECTION

Lavello Fox 360 - M79 Nuvola
Miscelatore Chef - CR Cromo
Piano cottura Plano 90 - G40 Nero
Forno Plano - M79 Nuvola



Best COLLECTION

L'estetica moderna ispira linee essenziali e rigorose, che delineano la vasca capiente e il gocciolatoio premium di Best. Ogni elemento è studiato per ottimizzare lo spazio, interagire con gli accessori e mantenere il piano di lavoro pulito e ordinato.

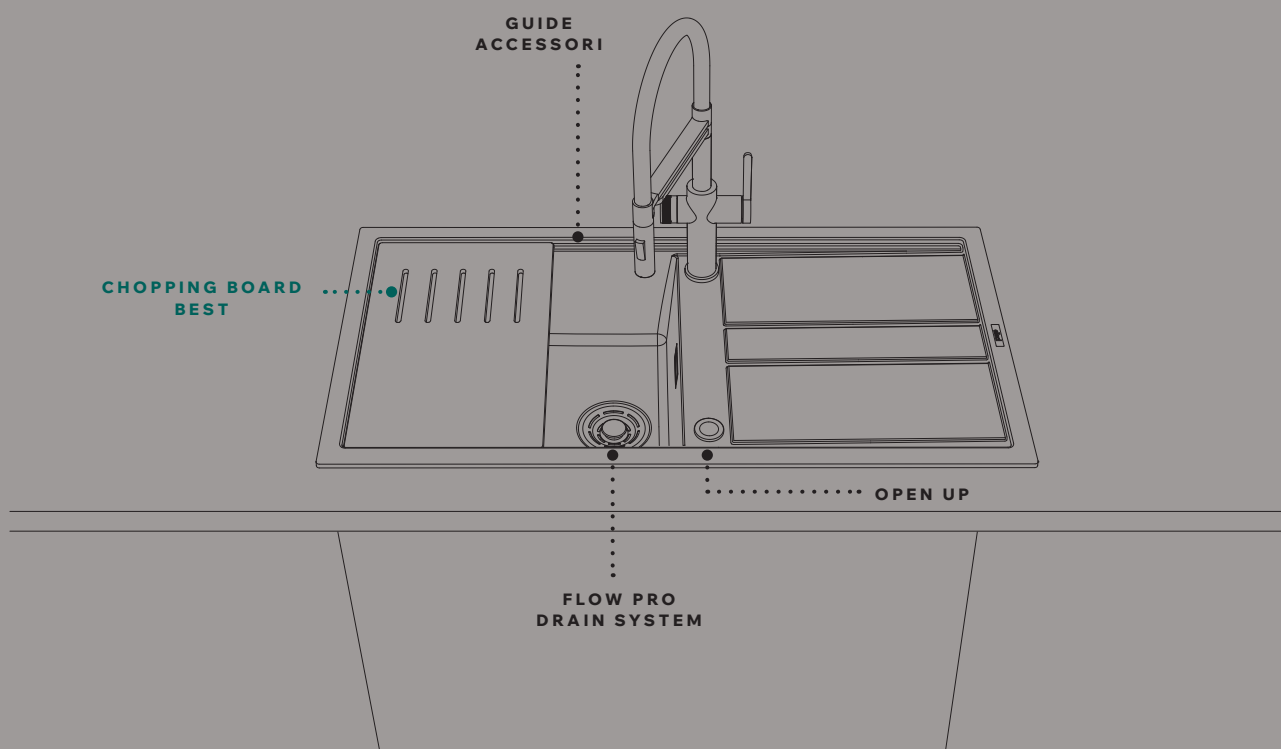

MODELLI BEST

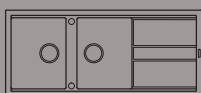

Best 500

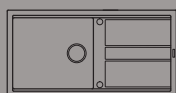

Best 480

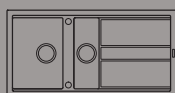

Best 475

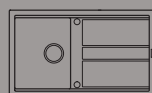

Best 400

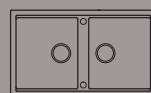

Best 450

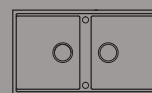

Best 450
Sottotop



Lavello Best 480 - K86 Black
Miscelatore Ventum - BK Black

GRANITEK



KERATEK



Best COLLECTION

Best 500

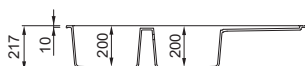
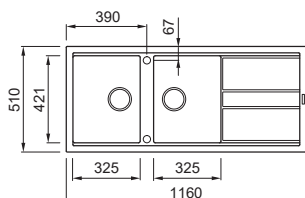

Best 480

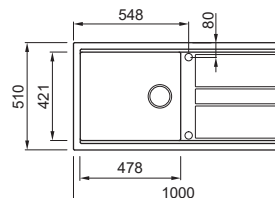

LAVELLO 2 VASCHE CON GOCCIOLATOIO

Dimensioni	1160 x 510 mm
Base	800 mm
Foro da incasso	1140 x 480 mm
Profondità vasca	200 mm e 200mm
Banco rubinetteria	Si
Installazione	Sopratop
Orientamento	Reversibile

GRANITEK

€ 540

- G40** Nero LGB50040
- G78** Espresso LGB50078
- G48** Cemento LGB50048
- G43** Tortora LGB50043
- M79** Nuvola LMB50079
- G39** Bianco Soft LGB50039
- G68** Bianco LGB50068
- G59** Antracite LGB50059
- G51** Avena LGB50051
- G62** Bianco Antico LGB50062

KERATEK

€ 720

- K86** Black LKB50086
- K87** Cocoa LKB50087
- K99** Concrete LKB50099
- K89** Dove LKB50089
- K88** Cloud LKB50088
- K95** Champagne LKB50095
- K96** White LKB50096

LAVELLO 1 VASCA CON GOCCIOLATOIO

Dimensioni	1000 x 510 mm
Base	600 mm
Foro da incasso	980 x 480 mm
Profondità vasca	200 mm
Banco rubinetteria	Si
Installazione	Sopratop
Orientamento	Reversibile

GRANITEK

€ 520

- G40** Nero LGB48040
- G78** Espresso LGB48078
- G48** Cemento LGB48048
- G43** Tortora LGB48043
- M79** Nuvola LMB48079
- G39** Bianco Soft LGB48039
- G68** Bianco LGB48068
- G59** Antracite LGB48059
- G51** Avena LGB48051
- G62** Bianco Antico LGB48062

KERATEK

€ 700

- K86** Black LKB48086
- K87** Cocoa LKB48087
- K99** Concrete LKB48099
- K89** Dove LKB48089
- K88** Cloud LKB48088
- K95** Champagne LKB48095
- K96** White LKB48096

Best COLLECTION

Best 475

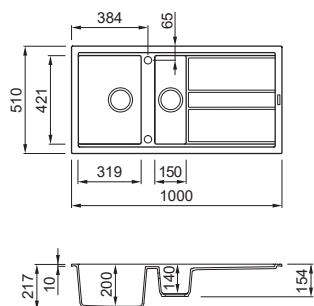

Best 400

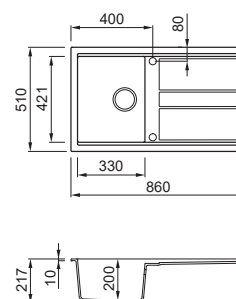

LAVELLO 2 VASCHE CON GOCCIOLATOIO

Dimensioni	1000 x 510 mm
Base	600 mm
Foro da incasso	980 x 480 mm
Profondità vasca	200 mm e 140 mm
Banco rubinetteria	Si
Installazione	Sopratop
Orientamento	Reversibile

GRANITEK

€ 530

- G40** Nero LGB47540
- G78** Espresso LGB47578
- G48** Cemento LGB47548
- G43** Tortora LGB47543
- M79** Nuvola LMB47579
- G39** Bianco Soft LGB47539
- G68** Bianco LGB47568
- G59** Antracite LGB47559
- G51** Avena LGB47551
- G62** Bianco Antico LGB47562

KERATEK

€ 710

- K86** Black LKB47586
- K87** Cocoa LKB47587
- K99** Concrete LKB47599
- K89** Dove LKB47589
- K88** Cloud LKB47588
- K95** Champagne LKB47595
- K96** White LKB47596

LAVELLO 1 VASCA CON GOCCIOLATOIO

Dimensioni	860 x 510 mm
Base	450 mm
Foro da incasso	840 x 480 mm
Profondità vasca	200 mm
Banco rubinetteria	Si
Installazione	Sopratop
Orientamento	Reversibile

GRANITEK

€ 460

- G40** Nero LGB40040
- G78** Espresso LGB40078
- G48** Cemento LGB40048
- G43** Tortora LGB40043
- M79** Nuvola LMB40079
- G39** Bianco Soft LGB40039
- G68** Bianco LGB40068
- G59** Antracite LGB40059
- G51** Avena LGB40051
- G62** Bianco Antico LGB40062

KERATEK

€ 620

- K86** Black LKB40086
- K87** Cocoa LKB40087
- K99** Concrete LKB40099
- K89** Dove LKB40089
- K88** Cloud LKB40088
- K95** Champagne LKB40095
- K96** White LKB40096

Best COLLECTION

Best 450

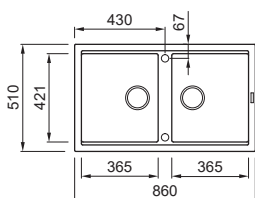
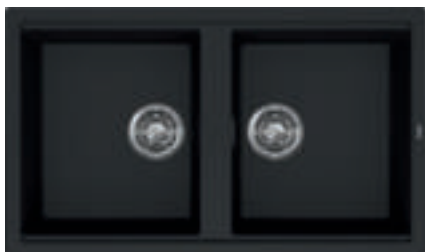

Best 450 Sottotop

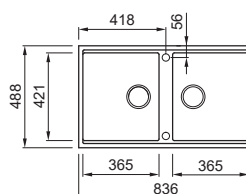
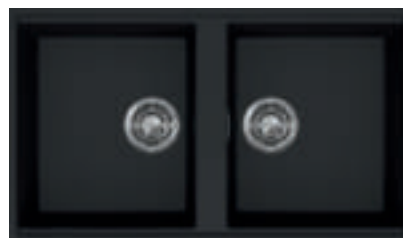

LAVELLO 2 VASCHE

Dimensioni	860 x 510 mm
Base	900 mm
Foro da incasso	840 x 480 mm
Profondità vasca	200 mm e 200mm
Banco rubinetteria	Si
Installazione	Sopratop
Orientamento	Reversibile

GRANITEK

€ 490

- G40** Nero LGB45040
- G78** Espresso LGB45078
- G48** Cemento LGB45048
- G43** Tortora LGB45043
- M79** Nuvola LMB45079
- G39** Bianco Soft LGB45039
- G68** Bianco LGB45068
- G59** Antracite LGB45059
- G51** Avena LGB45051
- G62** Bianco Antico LGB45062

KERATEK

€ 650

- K86** Black LKB45086
- K87** Cocoa LKB45087
- K99** Concrete LKB45099
- K89** Dove LKB45089
- K88** Cloud LKB45088
- K95** Champagne LKB45095
- K96** White LKB45096

LAVELLO 2 VASCHE

Dimensioni	836 x 488 mm
Base	900 mm
Foro da incasso	795 x 448 mm R6
Profondità vasca	200 mm e 200 mm
Banco rubinetteria	Si
Installazione	Sottotop
Orientamento	Reversibile

GRANITEK

€ 510

- G40** Nero LGB45040BSO
- G78** Espresso LGB45078BSO
- G48** Cemento LGB45048BSO
- G43** Tortora LGB45043BSO
- M79** Nuvola LMB45079BSO
- G39** Bianco Soft LGB45039BSO
- G68** Bianco LGB45068BSO
- G59** Antracite LGB45059BSO
- G51** Avena LGB45051BSO
- G62** Bianco Antico LGB45062BSO

KERATEK

€ 680

- K86** Black LKB45086BSO
- K87** Cocoa LKB45087BSO
- K99** Concrete LKB45099BSO
- K89** Dove LKB45089BSO
- K88** Cloud LKB45088BSO
- K95** Champagne LKB45095BSO
- K96** White LKB45096BSO

Best COLLECTION

IDEE DI STILE

Ventum PURE new

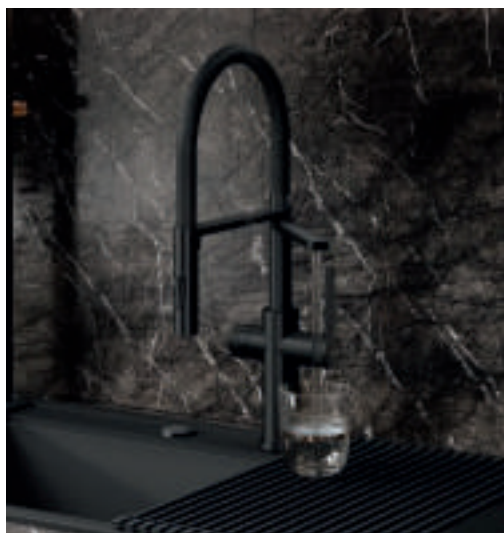

Caratteristiche tecniche ed altre finiture a pag. 181

ELLECI PURE
AFICAMGR € 350



● BK Black
MOKVNTBK € 440

COMPATIBILITÀ ACCESSORI LAVELLO

CHOPPING BOARD
BEST LINE



● BK Black
ATH020BK € 110
● QU Quercia
ATH020QU € 110

DRAINER FLEX
500

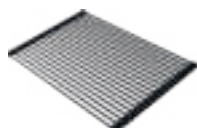

● BK Black
ARS023BK € 90
● GR Grey
ARS023GR € 90

TUTTI I MODELLI

TUTTI I MODELLI

TUTTI I MODELLI

SOAP DISPENSER
TONDO



● BK Black
ADI02304BK € 70
● GM Gun metal
ADI02304GM € 70
● CR Cromo
ADI02304CR € 60

SOAP DISPENSER
QUADRATO



● CR Cromo
ADI02301 € 100

TUTTI I MODELLI

POD 250



● BK Black
APS250BK € 80
● GR Grey
APS250GR € 80

DRAIN SYSTEM

KIT FLOW PRO



● BK Black
KITWPT-F-1VSELL-BK € 115
● GM Gun metal
KITWPT-F-1VSELL-GM € 100
● IN Inox
KITWPT-F-1VSELL-IN € 50

TUTTI I MODELLI

KIT FLOW PRO OPEN UP



● BK Black
KITASP-F-1VSELL-BK € 150
● GM Gun metal
KITASP-F-1VSELL-GM € 150
● IN Inox
KITASP-F-1VSELL-IN € 80

TUTTI I MODELLI

KIT FLOW PRO OPEN TWIST



● BK Black
KITASPT-F-1VSELL-BK € 150
● IN Inox
KITASPT-F-1VSELL-IN € 80

TUTTI I MODELLI

ELLECI ZERO



Serie 60
TDZ060GR € 380
Serie 100
TDZ100GR € 450

TUTTI I MODELLI

Unico

COLLECTION

Unico è il lavello con vasca spaziosa e gocciolatoio dal design minimal, che si declina in modelli differenti per adattarsi a cucine di ogni modularità. Il nuovo Flow Drain System aggiunge bellezza e funzionalità in un unico dettaglio.

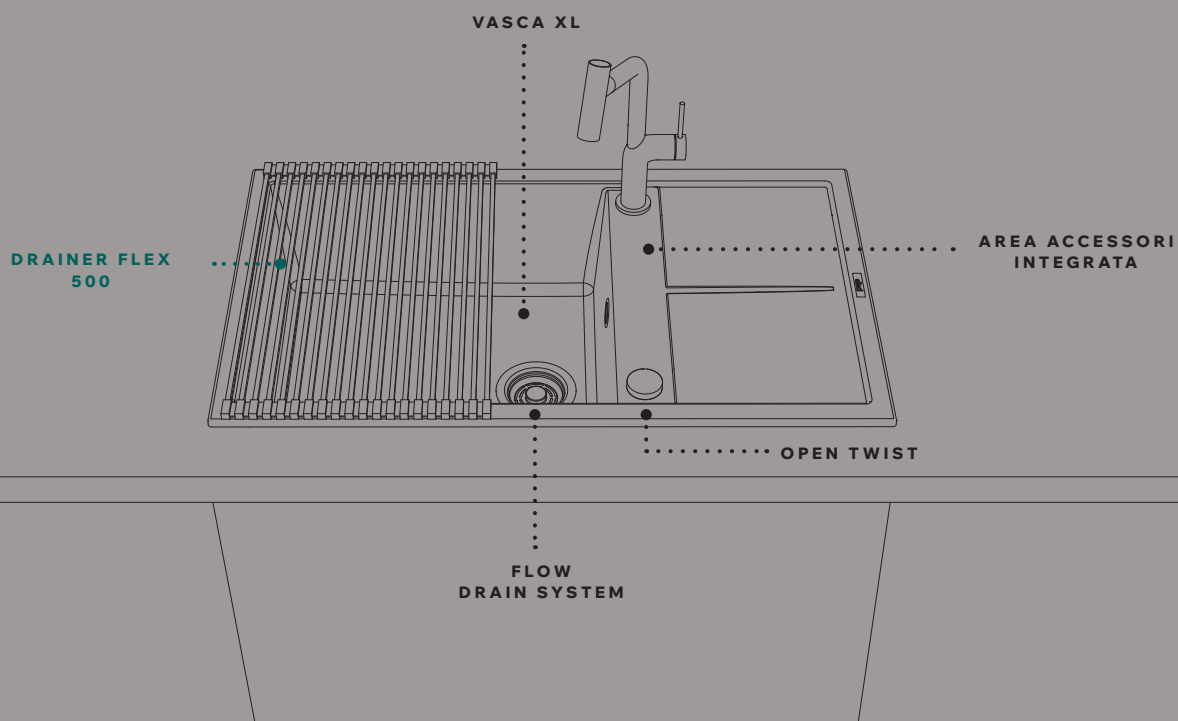

MODELLI UNICO

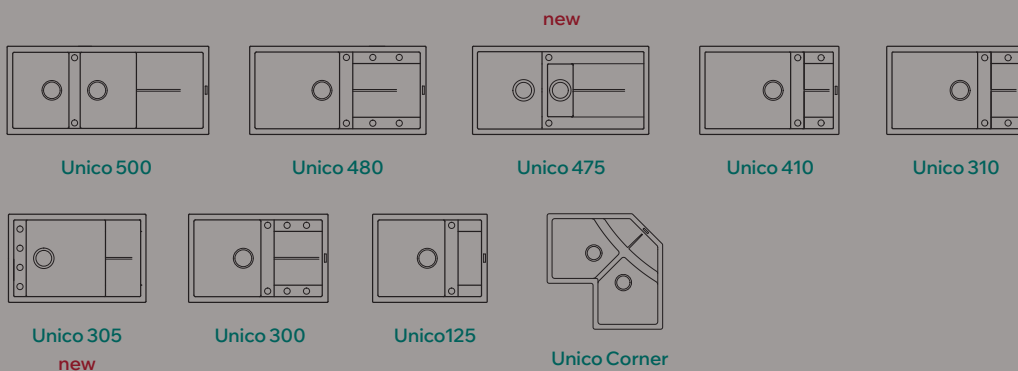



Lavello Unico 410 - G40 Nero
Miscelatore Loch - GM Gun Metal

GRANITEK



KERATEK



Unico

COLLECTION

Il lavello diventa il cuore di una cucina ben organizzata: il banco rubinetteria laterale dà la possibilità agli accessori di scorrere lungo tutta la vasca, creando un piano di lavoro armonioso che non rinuncia a nulla.

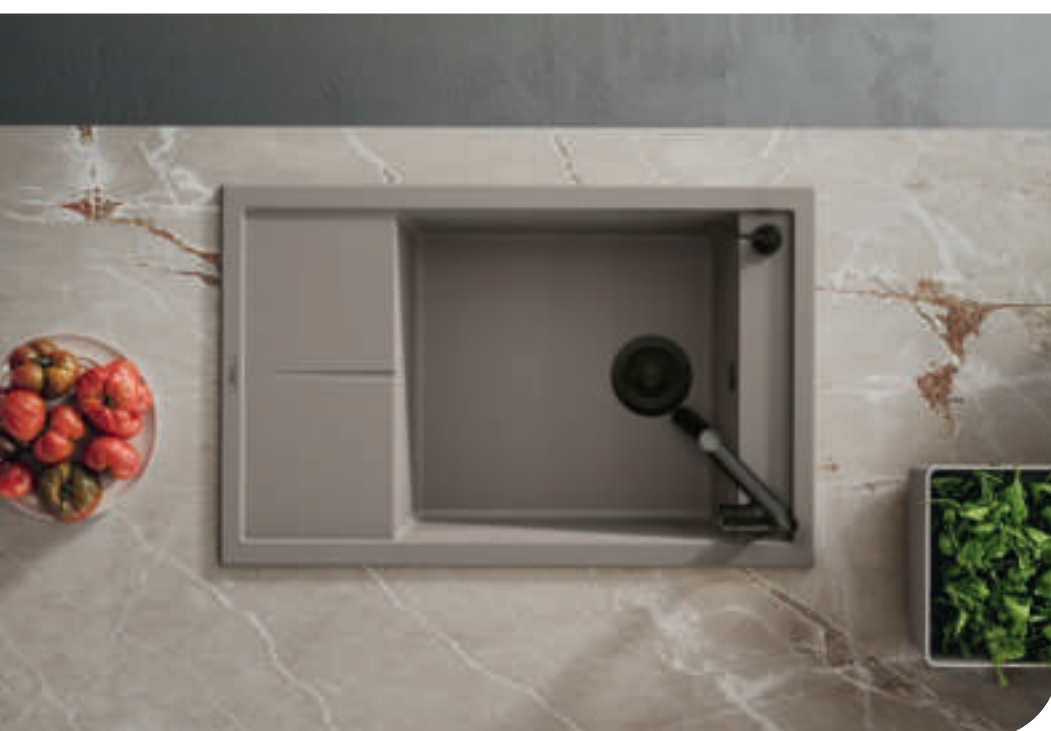

NEW
UNICO 305



Unico COLLECTION

Unico 500

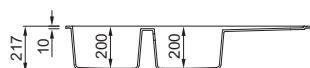
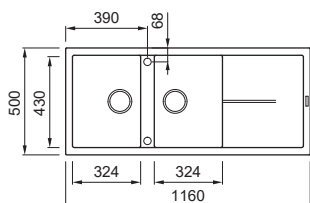

Unico 480

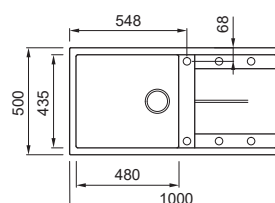

LAVELLO 2 VASCHE CON GOCCIOLATOIO

Dimensioni 1160 x 500 mm
 Base 800 mm
 Foro da incasso 1140 x 480 mm
 Profondità vasca 200 mm e 200mm
 Banco rubinetteria Si
 Installazione Sopratop
 Orientamento Reversibile

GRANITEK

KERATEK

- € 500
- G40 Nero LGU50040
- G78 Espresso LGU50078
- G48 Cemento LGU50048
- G43 Tortora LGU50043
- M79 Nuvola LMU50079
- G39 Bianco Soft LGU50039
- G68 Bianco LGU50068
- G59 Antracite LGU50059
- G51 Avena LGU50051
- G62 Bianco Antico LGU50062

- € 650
- K86 Black LKU50086
- K87 Cocoa LKU50087
- K99 Concrete LKU50099
- K89 Dove LKU50089
- K88 Cloud LKU50088
- K95 Champagne LKU50095
- K96 White LKU50096

LAVELLO 1 VASCA CON GOCCIOLATOIO

Dimensioni 1000 x 500 mm
 Base 600 mm
 Foro da incasso 980 x 480 mm
 Profondità vasca 200 mm
 Banco rubinetteria Si
 Installazione Sopratop
 Orientamento Reversibile

GRANITEK

KERATEK

- € 490
- G40 Nero LGU48040
- G78 Espresso LGU48078
- G48 Cemento LGU48048
- G43 Tortora LGU48043
- M79 Nuvola LMU48079
- G39 Bianco Soft LGU48039
- G68 Bianco LGU48068
- G59 Antracite LGU48059
- G51 Avena LGU48051
- G62 Bianco Antico LGU48062

- € 640
- K86 Black LKU48086
- K87 Cocoa LKU48087
- K99 Concrete LKU48099
- K89 Dove LKU48089
- K88 Cloud LKU48088
- K95 Champagne LKU48095
- K96 White LKU48096

Unico COLLECTION

Unico 475 new

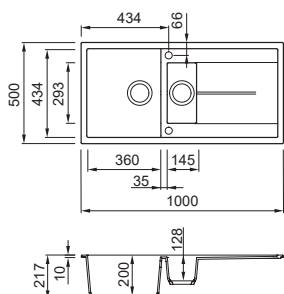

Unico 410

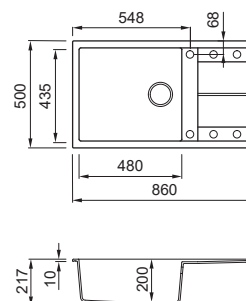

LAVELLO 2 VASCHE CON GOCCIOLATOIO

Dimensioni	1000 x 500 mm
Base	600 mm
Foro da incasso	980 x 480 mm
Profondità vasca	200 mm e 128 mm
Banco rubinetteria	Si
Installazione	Sopratop
Orientamento	Reversibile

GRANITEK

€ 490

- G40 Nero LGU47540
- G78 Espresso LGU47578
- G48 Cemento LGU47548
- G43 Tortora LGU47543
- M79 Nuvola LMU47579
- G39 Bianco Soft LGU47539
- G68 Bianco LGU47568
- G59 Antracite LGU47559
- G51 Avena LGU47551
- G62 Bianco Antico LGU47562

KERATEK

€ 640

- K86 Black LKU47586
- K87 Cocoa LKU47587
- K99 Concrete LKU47599
- K89 Dove LKU47589
- K88 Cloud LKU47588
- K95 Champagne LKU47595
- K96 White LKU47596

LAVELLO 1 VASCA CON GOCCIOLATOIO

Dimensioni	860 x 500 mm
Base	600 mm
Foro da incasso	840 x 480 mm
Profondità vasca	200 mm
Banco rubinetteria	Si
Installazione	Sopratop
Orientamento	Reversibile

GRANITEK

€ 430

- G40 Nero LGU41040
- G78 Espresso LGU41078
- G48 Cemento LGU41048
- G43 Tortora LGU41043
- M79 Nuvola LMU41079
- G39 Bianco Soft LGU41039
- G68 Bianco LGU41068
- G59 Antracite LGU41059
- G51 Avena LGU41051
- G62 Bianco Antico LGU41062

KERATEK

€ 570

- K86 Black LKU41086
- K87 Cocoa LKU41087
- K99 Concrete LKU41099
- K89 Dove LKU41089
- K88 Cloud LKU41088
- K95 Champagne LKU41095
- K96 White LKU41096

Unico COLLECTION

Unico 310

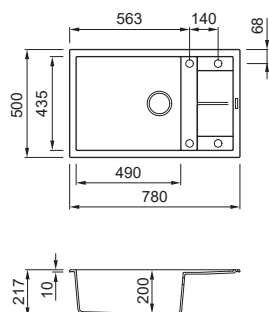

Unico 305 new

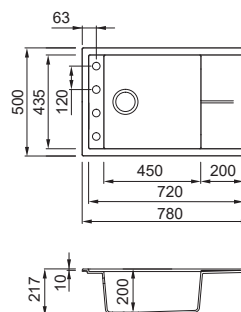

LAVELLO 1 VASCA CON GOCCIOLATOIO

Dimensioni	780 x 500 mm
Base	600 750 mm se inizio composizione
Foro da incasso	760 x 480 mm
Profondità vasca	200 mm
Banco rubinetteria	Si
Installazione	Sopratop
Orientamento	Reversibile

GRANITEK

€ 430

- G40 Nero LGU31040
- G78 Espresso LGU31078
- G48 Cemento LGU31048
- G43 Tortora LGU31043
- M79 Nuvola LMU31079
- G39 Bianco Soft LGU31039
- G68 Bianco LGU31068
- G59 Antracite LGU31059
- G51 Avena LGU31051
- G62 Bianco Antico LGU31062

KERATEK

€ 570

- K86 Black LKU31086
- K87 Cocoa LKU31087
- K99 Concrete LKU31099
- K89 Dove LKU31089
- K88 Cloud LKU31088
- K95 Champagne LKU31095
- K96 White LKU31096

LAVELLO 1 VASCA CON GOCCIOLATOIO

Dimensioni	780 x 500 mm
Base	600 mm
Foro da incasso	760 x 480 mm
Profondità vasca	200 mm
Banco rubinetteria	Si
Installazione	Sopratop
Orientamento	Reversibile

GRANITEK

€ 430

- G40 Nero LGU30540
- G78 Espresso LGU30578
- G48 Cemento LGU30548
- G43 Tortora LGU30543
- M79 Nuvola LMU30579
- G39 Bianco Soft LGU30539
- G68 Bianco LGU30568
- G59 Antracite LGU30559
- G51 Avena LGU30551
- G62 Bianco Antico LGU30562

KERATEK

€ 570

- K86 Black LKU30586
- K87 Cocoa LKU30587
- K99 Concrete LKU30599
- K89 Dove LKU30589
- K88 Cloud LKU30588
- K95 Champagne LKU30595
- K96 White LKU30596

Unico

COLLECTION

Unico 300

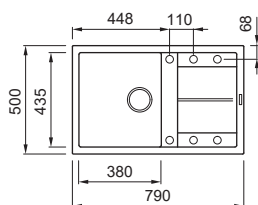

Unico 125

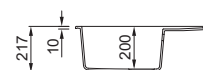
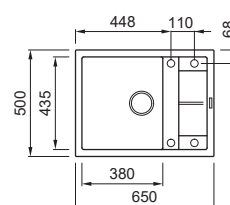

LAVELLO 1 VASCA CON GOCCIOLATOIO

Dimensioni	790 x 500 mm
Base	500 mm
Foro da incasso	770 x 480 mm
Profondità vasca	200 mm
Banco rubinetteria	Si
Installazione	Sopratop
Orientamento	Reversibile

GRANITEK

€ 420

G40	Nero LGU30040
G78	Espresso LGU30078
G48	Cemento LGU30048
G43	Tortora LGU30043
M79	Nuvola LMU30079
G39	Bianco Soft LGU30039
G68	Bianco LGU30068
G59	Antracite LGU30059
G51	Avena LGU30051
G62	Bianco Antico LGU30062

KERATEK

€ 560

K86	Black LKU30086
K87	Cocoa LKU30087
K99	Concrete LKU30099
K89	Dove LKU30089
K88	Cloud LKU30088
K95	Champagne LKU30095
K96	White LKU30096

LAVELLO 1 VASCA CON GOCCIOLATOIO

Dimensioni	650 x 500 mm
Base	500 mm
Foro da incasso	630 x 480 mm
Profondità vasca	200 mm
Banco rubinetteria	Si
Installazione	Sopratop
Orientamento	Reversibile

GRANITEK

€ 390

G40	Nero LGU12540
G78	Espresso LGU12578
G48	Cemento LGU12548
G43	Tortora LGU12543
M79	Nuvola LMU12579
G39	Bianco Soft LGU12539
G68	Bianco LGU12568
G59	Antracite LGU12559
G51	Avena LGU12551
G62	Bianco Antico LGU12562

KERATEK

€ 510

K86	Black LKU12586
K87	Cocoa LKU12587
K99	Concrete LKU12599
K89	Dove LKU12589
K88	Cloud LKU12588
K95	Champagne LKU12595
K96	White LKU12596

Unico COLLECTION

Unico Corner

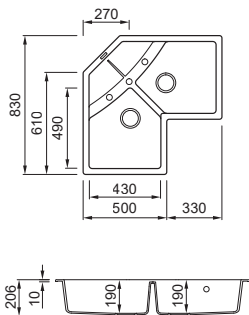

LAVELLO 2 VASCHE CON GOCCIOLATOIO

Dimensioni	830 x 830 mm
Base	Angolo
Foro da incasso	Da dima*
Profondità vasca	190 mm e 190 mm
Banco rubinetteria	Si
Installazione	Sopratop
Orientamento	Reversibile

GRANITEK

€ 680

- G40** Nero LGUCOR40
- G78** Espresso LGUCOR78
- G48** Cemento LGUCOR48
- G43** Tortora LGUCOR43
- M79** Nuvola LMUCOR79
- G39** Bianco Soft LGUCOR39
- G68** Bianco LGUCOR68
- G59** Antracite LGUCOR59
- G51** Avena LGUCOR51
- G62** Bianco Antico LGUCOR62



Lavello Unico Corner - G 40 Nero
Miscelatore Trail - G 40 Nero

Unico

COLLECTION

Unico 410 **new**

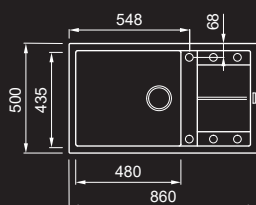

LAVELLO 1 VASCA CON GOCCIOLATOIO

Dimensioni	860 x 500 mm
Base	600 mm
Foro da incasso	840 x 480 mm
Profondità vasca	200 mm
Banco rubinetteria	Si
Installazione	Sopratop
Orientamento	Reversibile

GRANITEK

€ 460

G40

Nero
LGU41040BKM

KERATEK

€ 600

K86

Black
LKU41086BKM

Unico 305 **new**

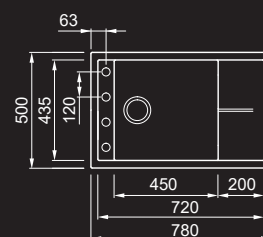

LAVELLO 1 VASCA CON GOCCIOLATOIO

Dimensioni	780 x 500 mm
Base	600 mm
Foro da incasso	760 x 480 mm
Profondità vasca	200 mm
Banco rubinetteria	Si
Installazione	Sopratop
Orientamento	Reversibile

GRANITEK

€ 460

G40

Nero
LGU30540BKM

KERATEK

€ 600

K86

Black
LKU30586BKM

CORREDO

Sifone salvaspazio, Flow, Troppopieno tondo, Kit di fissaggio.

COMPONENTI



Troppopieno
Tondo



Flow

FINITURE



BK Black

Unico COLLECTION

IDEE DI STILE

Loch new



Caratteristiche tecniche ed altre finiture a pag. 187

● BK Black
MOKLOCBK € 370

COMPATIBILITÀ ACCESSORI LAVELLO

CHOPPING BOARD SLIDING 50



● BK Black
ATH010BK € 130
● QU Quercia
ATH010QU € 130

TUTTI I MODELLI

DRAINER FLEX 500

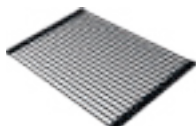

● BK Black
ARS023BK € 90
● GR Grey
ARS023GR € 90

TUTTI I MODELLI

TUTTI I MODELLI

SOAP DISPENSER TONDO



● BK Black
ADI02304BK € 70
● GM Gun metal
ADI02304GM € 70
● CR Cromo
ADI02304CR € 60

TUTTI I MODELLI

SOAP DISPENSER QUADRATO



● CR Cromo
ADI02301 € 100

POD 250



● BK Black
APS250BK € 80
● GR Grey
APS250GR € 80

DRAIN SYSTEM

FLOW SYSTEM



● BK Black
KITWPT-FB-1VTELL-BK € 35
● IN Inox
KITWPT-FB-1VTELL-IN € 30

TUTTI I MODELLI

FLOW OPEN UP



● BK Black
KITASP-FB-1VTELL-BK € 80
● IN Inox
KITASP-FB-1VTELL-IN € 70

TUTTI I MODELLI

FLOW OPEN TWIST



● BK Black
KITASPT-FB-1VTELL-BK € 80
● IN Inox
KITASPT-FB-1VTELL-IN € 70

TUTTI I MODELLI

ELLECI ZERO



Serie 60
TDZ060GR € 380
Serie 100
TDZ100GR € 450

TUTTI I MODELLI

Unico

COLLECTION

Lavello Unico 305 - G43 Tortora
Miscelatore Loch - BK Black
Piano cottura Urban 80 Induction - CD City Dune
Forno Urban Plus - BK Black



DISPONIBILE IN TUTTI I COLORI KERATEK E GRANITEK, LA COLLEZIONE UNICO
DEFINISCE SPAZI PERSONALIZZATI E DISTINTIVI.

Ego

COLLECTION

La collezione Ego si distingue per il design naturale e avvolgente, che dona un tocco di leggerezza all'ambiente. Le sue linee sinuose abbracciano lo spazio, riflesso di una personalità autentica e sofisticata.

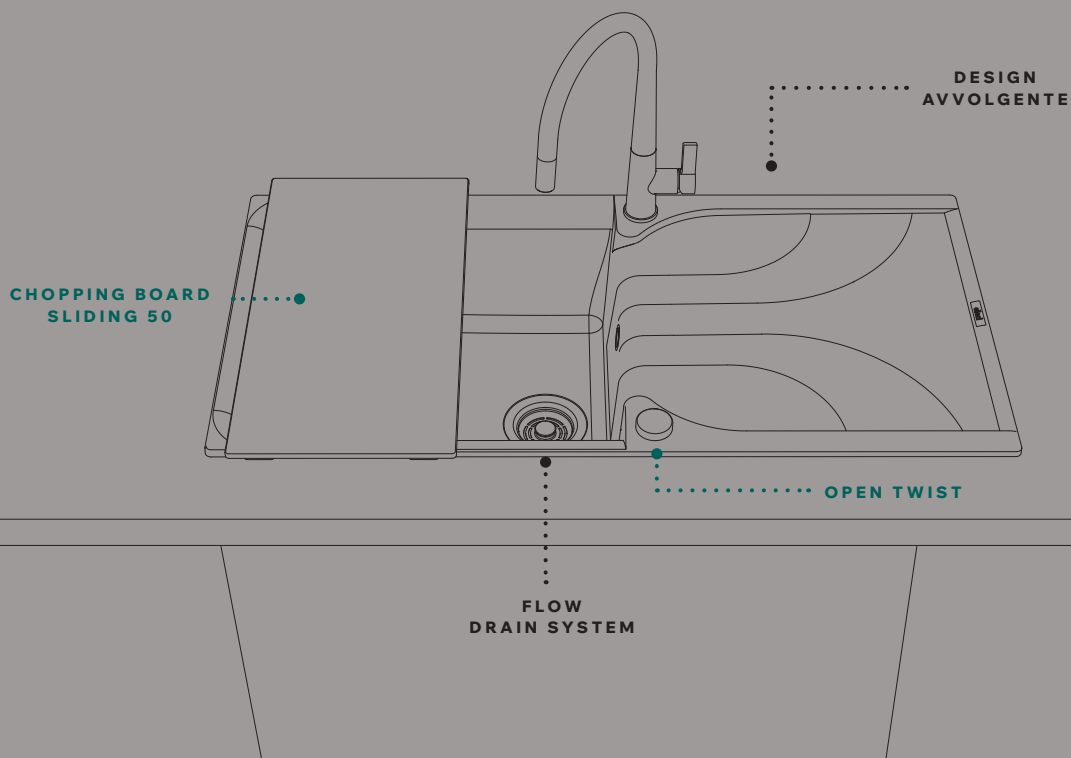

MODELLI EGO



Ego 500

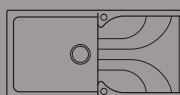

Ego 480

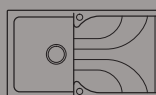

Ego 400

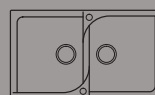

Ego 450



Ego Round



Lavello Ego 480 - G68 Bianco
Miscelatore Athena - G68 Bianco

GRANITEK

G40
NERO

G78
ESPRESSO

G48
CEMENTO

G43
TORTORA

M79
NUVOLA

G39
BIANCO
SOFT

G68
BIANCO

G59
ANTRACITE

G51
AVENA

G62
BIANCO
ANTICO

Ego COLLECTION

Ego 500

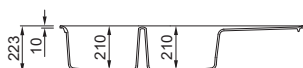
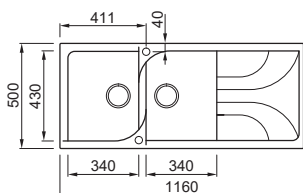

Ego 480

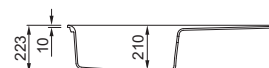
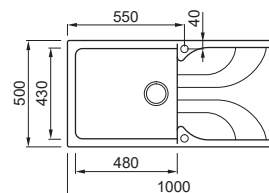
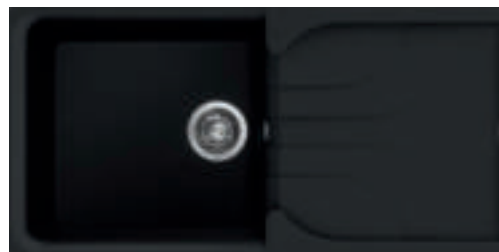

LAVELLO 2 VASCHE CON GOCCIOLATOIO

Dimensioni	1160 x 500 mm
Base	800 mm
Foro da incasso	1140 x 485 mm
Profondità vasca	210 mm e 210mm
Banco rubinetteria	Si
Installazione	Sopratop
Orientamento	Reversibile

GRANITEK

€ 470

- G40** Nero LGE50040
- G78** Espresso LGE50078
- G48** Cemento LGE50048
- G43** Tortora LGE50043
- M79** Nuvola LME50079
- G39** Bianco Soft LGE50039
- G68** Bianco LGE50068
- G59** Antracite LGE50059
- G51** Avena LGE50051
- G62** Bianco Antico LGE50062

LAVELLO 1 VASCA CON GOCCIOLATOIO

Dimensioni	1000 x 500 mm
Base	600 mm
Foro da incasso	980 x 485 mm
Profondità vasca	210 mm
Banco rubinetteria	Si
Installazione	Sopratop
Orientamento	Reversibile

GRANITEK

€ 460

- G40** Nero LGE48040
- G78** Espresso LGE48078
- G48** Cemento LGE48048
- G43** Tortora LGE48043
- M79** Nuvola LME48079
- G39** Bianco Soft LGE48039
- G68** Bianco LGE48068
- G59** Antracite LGE48059
- G51** Avena LGE48051
- G62** Bianco Antico LGE48062

Ego COLLECTION

Ego 400

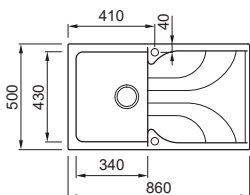

LAVELLO 1 VASCA CON GOCCIOLATOIO

Dimensioni	860 x 500 mm
Base	450 mm
Foro da incasso	840 x 490 mm
Profondità vasca	210 mm
Banco rubinetteria	Si
Installazione	Sopratop
Orientamento	Reversibile

GRANITEK

€ 410

- G40 Nero
LGE40040
- G78 Espresso
LGE40078
- G48 Cemento
LGE40048
- G43 Tortora
LGE40043
- M79 Nuvola
LME40079
- G39 Bianco Soft
LGE40039
- G68 Bianco
LGE40068
- G59 Antracite
LGE40059
- G51 Avena
LGE40051
- G62 Bianco Antico
LGE40062

CORREDO
Sifone salvaspazio, Flow, Troppopieno tondo, Kit di fissaggio.

COMPONENTI



FINITURE



Ego COLLECTION

Ego 450

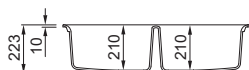
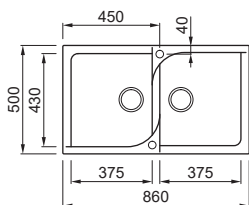

LAVELLO 2 VASCHE

Dimensioni	860 x 500 mm
Base	900 mm
Foro da incasso	840 x 485 mm
Profondità vasca	210 mm e 210mm
Banco rubinetteria	Si
Installazione	Sopratop
Orientamento	Reversibile

GRANITEK

€ 430

- G40** Nero LGE45040
- G78** Espresso LGE45078
- G48** Cemento LGE45048
- G43** Tortora LGE45043
- M79** Nuvola LME45079
- G39** Bianco Soft LGE45039
- G68** Bianco LGE45068
- G59** Antracite LGE45059
- G51** Avena LGE45051
- G62** Bianco Antico LGE45062

Ego Round

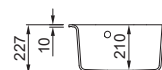
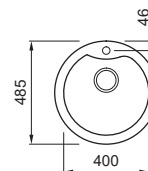

LAVELLO 1 VASCA

Dimensioni	Ø 485 mm
Base	500 mm
Foro da incasso	Ø 465 mm
Profondità vasca	210 mm
Banco rubinetteria	Si
Installazione	Sopratop

GRANITEK

€ 320

- G40** Nero LGEROU40
- G78** Espresso LGEROU78
- G48** Cemento LGEROU48
- G43** Tortora LGEROU43
- M79** Nuvola LMEROU79
- G39** Bianco Soft LGEROU39
- G68** Bianco LGEROU68
- G59** Antracite LGEROU59
- G51** Avena LGEROU51
- G62** Bianco Antico LGEROU62

Ego COLLECTION

IDEE DI STILE

Athena



Caratteristiche tecniche ed altre finiture a pag. 192

○ G 68 Bianco
MGKATH68 € 320

COMPATIBILITÀ ACCESSORI LAVELLO

CHOPPING BOARD
SLIDING 50



● BK Black
ATH010BK € 130
● QU Quercia
ATH010QU € 130

DRAINER FLEX
500

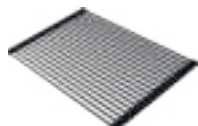

● BK Black
ARS023BK € 90
● GR Grey
ARS023GR € 90

TRANNE EGO ROUND

POD 250



● BK Black
APS250BK € 80
● GR Grey
APS250GR € 80

DRAIN SYSTEM

FLOW SYSTEM



● BK Black
KITWPT-FB-1VTELL-BK € 35
● IN Inox
KITWPT-FB-1VTELL-IN € 30

TUTTI I MODELLI

FLOW OPEN UP



● BK Black
KITASP-FB-1VTELL-BK € 80
● IN Inox
KITASP-FB-1VTELL-IN € 70



TRANNE EGO ROUND

FLOW OPEN TWIST



● BK Black
KITASPT-FB-1VTELL-BK € 80
● IN Inox
KITASPT-FB-1VTELL-IN € 70



TRANNE EGO ROUND

ELLECI ZERO



Serie 60
TDZ060GR € 380
Serie 100
TDZ100GR € 450

TUTTI I MODELLI

Easy

COLLECTION

Easy è il lavello che rende più semplice ogni gesto quotidiano. Versatile, pratico nell'uso, facile da pulire: con la sua vasca capiente e il comodo gocciolatoio è la scelta giusta per chi cerca bellezza senza complicazioni.

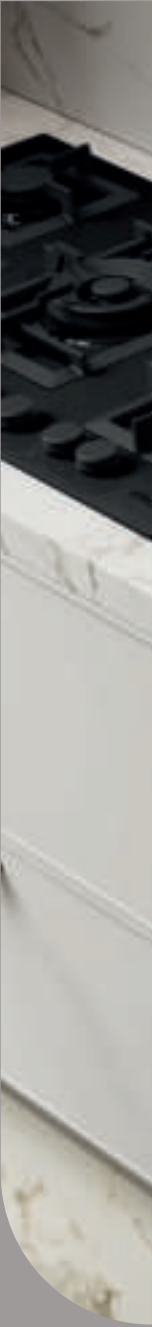
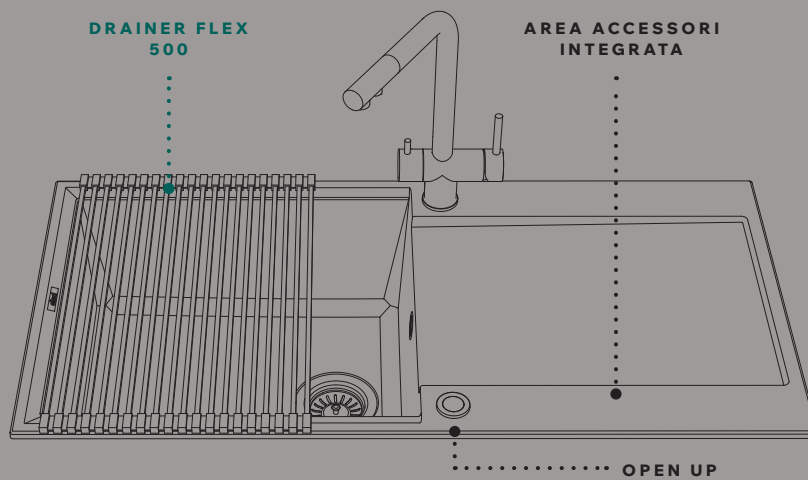

MODELLI EASY

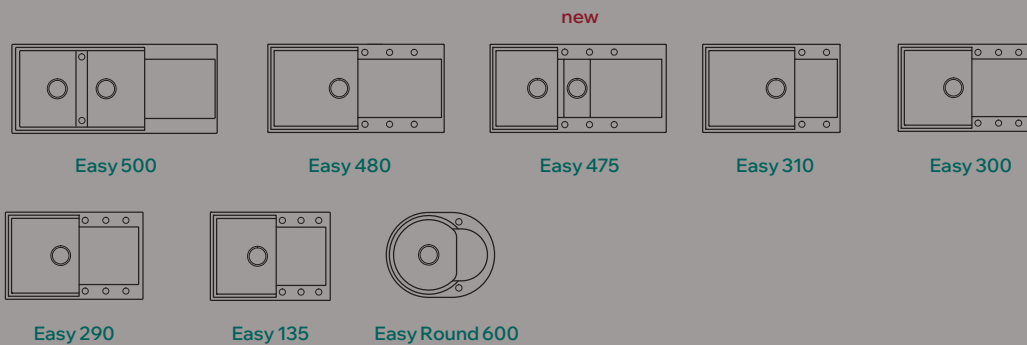



Lavello Easy 480 - M79 Nuvola
Miscelatore Tourmaline Pure - IN Inox

GRANITEK

G40
NERO

G78
ESPRESSO

G48
CEMENTO

G43
TORTORA

M79
NUVOLA

G39
BIANCO
SOFT

G68
BIANCO

G59
ANTRACITE

G51
AVENA

G62
BIANCO
ANTICO

Easy COLLECTION

Easy 500

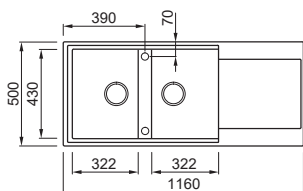

LAVELLO 2 VASCHE CON GOCCIOLATOIO

Dimensioni	1160 x 500 mm
Base	800 mm
Foro da incasso	1140 x 480 mm
Profondità vasca	200 mm e 200 mm
Banco rubinetteria	Si
Installazione	Sopratop
Orientamento	Reversibile

GRANITEK

€ 430

- G40** Nero LGY50040
- G78** Espresso LGY50078
- G48** Cemento LGY50048
- G43** Tortora LGY50043
- M79** Nuvola LMY50079
- G39** Bianco Soft LGY50039
- G68** Bianco LGY50068
- G59** Antracite LGY50059
- G51** Avena LGY50051
- G62** Bianco Antico LGY50062

Easy 480

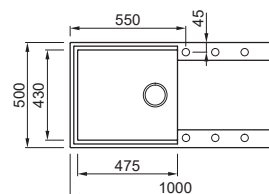

LAVELLO 1 VASCA CON GOCCIOLATOIO

Dimensioni	1000 x 500 mm
Base	600 mm
Foro da incasso	980 x 480 mm
Profondità vasca	200 mm
Banco rubinetteria	Si
Installazione	Sopratop
Orientamento	Reversibile

GRANITEK

€ 400

- G40** Nero LGY48040
- G78** Espresso LGY48078
- G48** Cemento LGY48048
- G43** Tortora LGY48043
- M79** Nuvola LMY48079
- G39** Bianco Soft LGY48039
- G68** Bianco LGY48068
- G59** Antracite LGY48059
- G51** Avena LGY48051
- G62** Bianco Antico LGY48062

Easy COLLECTION

Easy 475 new

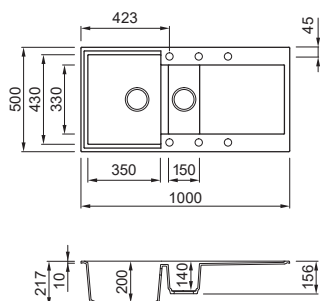
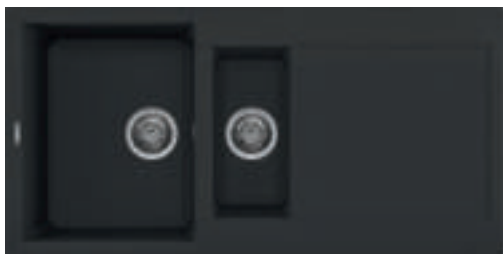

LAVELLO 2 VASCHE CON GOCCOLATOIO

Dimensioni	1000 x 500 mm
Base	600 750 mm se inizio composizione
Foro da incasso	980 x 480 mm
Profondità vasca	200 mm e 140 mm
Banco rubinetteria	Sì
Installazione	Sopratop
Orientamento	Reversibile

GRANITEK

€ 430

- G40 Nero LGY47540
- G78 Espresso LGY47578
- G48 Cemento LGY47548
- G43 Tortora LGY47543
- M79 Nuvola LMY47579
- G39 Bianco Soft LGY47539
- G68 Bianco LGY47568
- G59 Antracite LGY47559
- G51 Avena LGY47551
- G62 Bianco Antico LGY47562

Easy 310

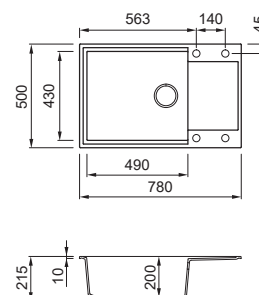
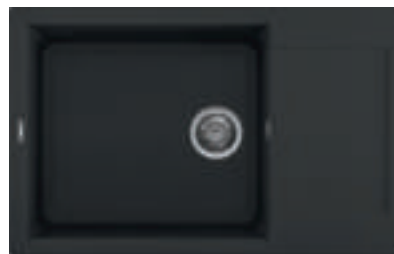

LAVELLO 1 VASCA CON GOCCOLATOIO

Dimensioni	780 x 500 mm
Base	600 750 mm se inizio composizione
Foro da incasso	760 x 480 mm
Profondità vasca	200 mm
Banco rubinetteria	Sì
Installazione	Sopratop
Orientamento	Reversibile

GRANITEK

€ 340

- G40 Nero LGY31040
- G78 Espresso LGY31078
- G48 Cemento LGY31048
- G43 Tortora LGY31043
- M79 Nuvola LMY31079
- G39 Bianco Soft LGY31039
- G68 Bianco LGY31068
- G59 Antracite LGY31059
- G51 Avena LGY31051
- G62 Bianco Antico LGY31062

Easy COLLECTION

Easy 300

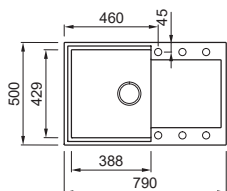
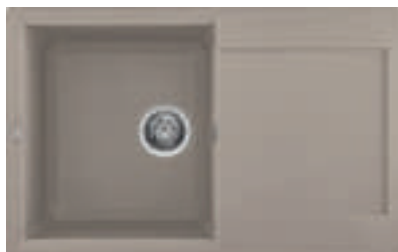

Easy 290

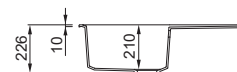
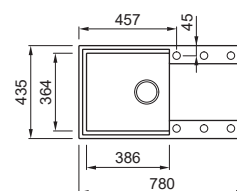

LAVELLO 1 VASCA CON GOCCIOLATOIO

Dimensioni	790 x 500 mm
Base	500 600 mm se inizio composizione
Foro da incasso	770 x 480 mm
Profondità vasca	220 mm
Banco rubinetteria	Si
Installazione	Sopratop
Orientamento	Reversibile

GRANITEK

€ 330

- G40** Nero LGY30040
- G78** Espresso LGY30078
- G48** Cemento LGY30048
- G43** Tortora LGY30043
- M79** Nuvola LMY30079
- G39** Bianco Soft LGY30039
- G68** Bianco LGY30068
- G59** Antracite LGY30059
- G51** Avena LGY30051
- G62** Bianco Antico LGY30062

LAVELLO 1 VASCA CON GOCCIOLATOIO

Dimensioni	780 x 435 mm
Base	500 600 mm se inizio composizione
Foro da incasso	760 x 415 mm
Profondità vasca	210 mm
Banco rubinetteria	Si
Installazione	Sopratop
Orientamento	Reversibile

GRANITEK

€ 330

- G40** Nero LGY29040
- G78** Espresso LGY29078
- G48** Cemento LGY29048
- G43** Tortora LGY29043
- M79** Nuvola LMY29079
- G39** Bianco Soft LGY29039
- G68** Bianco LGY29068
- G59** Antracite LGY29059
- G51** Avena LGY29051
- G62** Bianco Antico LGY29062

Easy COLLECTION

Easy 135

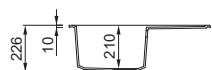
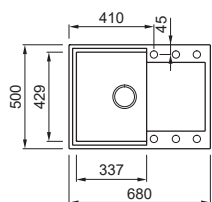
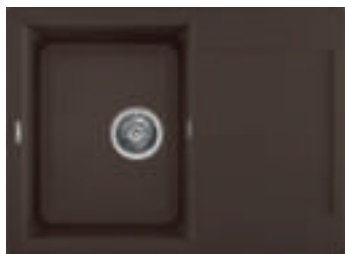

Easy Round 600

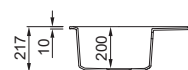
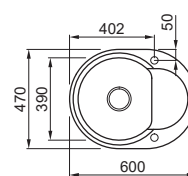

LAVELLO 1 VASCA CON GOCCIOLATOIO

Dimensioni	680 x 500 mm
Base	450 600 mm se inizio composizione
Foro da incasso	660 x 480 mm
Profondità vasca	210 mm
Banco rubinetteria	Si
Installazione	Sopratop
Orientamento	Reversibile

GRANITEK

€ 280

- G40 Nero LGY13540
- G78 Espresso LGY13578
- G48 Cemento LGY13548
- G43 Tortora LGY13543
- M79 Nuvola LMY13579
- G39 Bianco Soft LGY13539
- G68 Bianco LGY13568
- G59 Antracite LGY13559
- G51 Avena LGY13551
- G62 Bianco Antico LGY13562

LAVELLO 1 VASCA CON GOCCIOLATOIO

Dimensioni	600 x 470 mm
Base	450 mm
Foro da incasso	Da dima*
Profondità vasca	200 mm
Banco rubinetteria	Si
Installazione	Sopratop
Orientamento	Reversibile

GRANITEK

€ 270

- G40 Nero LGYR6040
- G78 Espresso LGYR6078
- G48 Cemento LGYR6048
- G43 Tortora LGYR6043
- M79 Nuvola LMYR6079
- G39 Bianco Soft LGYR6039
- G68 Bianco LGYR6068
- G59 Antracite LGYR6059
- G51 Avena LGYR6051
- G62 Bianco Antico LGYR6062

Easy COLLECTION

IDEE DI STILE

Tourmaline PURE



Caratteristiche tecniche ed altre finiture a pag. 180

ELLECI PURE
AFICAMGR € 350



● IN Inox
MIKTUIN € 310

DRAIN SYSTEM

BASE OPEN UP



● IN Inox
KITASP-A-1VTELL-IN € 45
● BK Black
KITASP-A-1VTELL-BK € 90

TUTTI I MODELLI

ELLECI ZERO



Serie 60
TDZ060GR € 380
Serie 100
TDZ100GR € 450

TUTTI I MODELLI

COMPATIBILITÀ ACCESSORI LAVELLO

CHOPPING BOARD
SLIDING 50



DRAINER FLEX
500

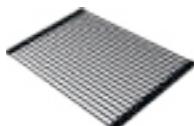

● BK Black
ATH010BK € 130
● QU Quercia
ATH010QU € 130

● BK Black
ARS023BK € 90
● GR Grey
ARS023GR € 90

MODELLI 500,480,310,300,135 MODELLI 500,480,310,300

SOAP DISPENSER
TONDO



SOAP DISPENSER
QUADRATO



● BK Black
ADI02304BK € 70
● GM Gun metal
ADI02304GM € 70
● CR Cromo
ADI02304CR € 60

● CR Cromo
ADI02301 € 100

MODELLI 480,310,300,290,135

POD 250



● BK Black
APS250BK € 80
● GR Grey
APS250GR € 80

Easy

COLLECTION

Lavello Easy 480 - M79 Nuvola
Miscelatore Tourmaline Pure - IN Inox
Piano cottura Plano 90 - G40 Nero
Forno Plano - G40 Nero



Life

COLLECTION

Nell'incontro tra classico e moderno nasce Life. Il lavello con angoli arrotondati e l'ampio gocciolatoio crea una postazione ergonomica, che invita all'uso, offrendo tutto lo spazio per lavorare con comodità.

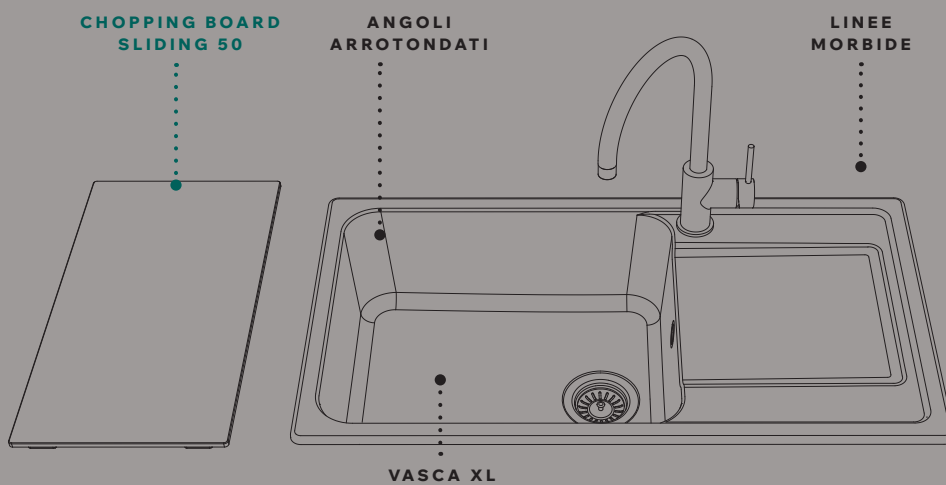

MODELLI LIFE

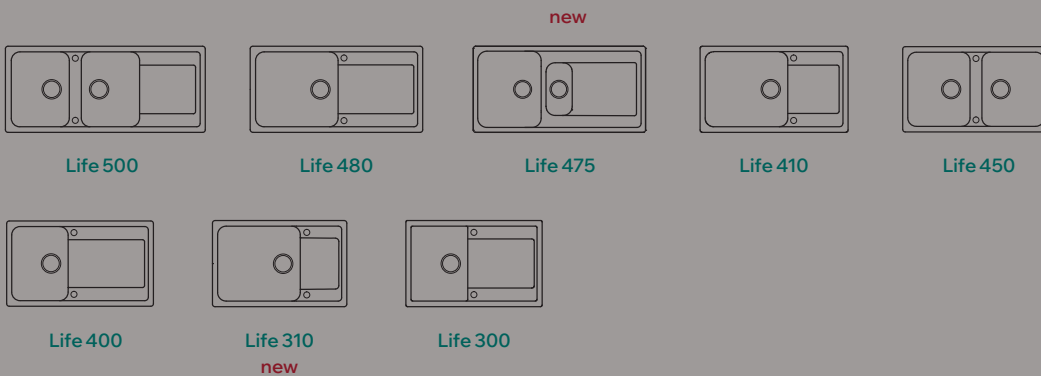



Lavello Life 410 - G39 Bianco Soft
Miscelatore Cloud - G39 Bianco Soft

GRANITEK



Life

COLLECTION

Life è la collezione di lavelli pensata per accompagnarti in ogni momento della giornata. Dal risveglio alla sera la cucina è lo spazio intimo e accogliente dove condividere chiacchiere, sorrisi e il piacere di stare insieme.





LA COMPATIBILITÀ CON ACCESSORI, COME IL TAGLIERE E IL DRAINER FLEX, ARRICCHISCE L'ESPERIENZA D'USO CON NUOVE FUNZIONALITÀ

Life COLLECTION

Life 500

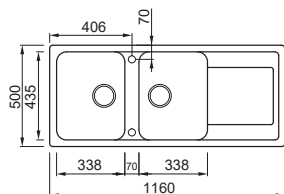

Life 480

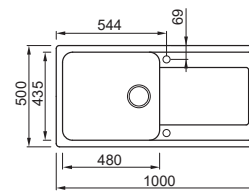

LAVELLO 2 VASCHE CON GOCCIOLATOIO

Dimensioni	1160 x 500 mm
Base	800 900 mm se inizio composizione
Foro da incasso	1140 x 480 mm
Profondità vasca	180 mm e 180mm
Banco rubinetteria	Si
Installazione	Sopratop
Orientamento	Reversibile

GRANITEK

€ 400

- G40** Nero LG250040
- G78** Espresso LG250078
- G48** Cemento LG250048
- G43** Tortora LG250043
- M79** Nuvola LM250079
- G39** Bianco Soft LG250039
- G68** Bianco LG250068
- G59** Antracite LG250059
- G51** Avena LG250051
- G62** Bianco Antico LG250062

LAVELLO 1 VASCA CON GOCCIOLATOIO

Dimensioni	1000 x 500 mm
Base	600 mm
Foro da incasso	980 x 480 mm
Profondità vasca	180 mm
Banco rubinetteria	Si
Installazione	Sopratop
Orientamento	Reversibile

GRANITEK

€ 390

- G40** Nero LG248040
- G78** Espresso LG248078
- G48** Cemento LG248048
- G43** Tortora LG248043
- M79** Nuvola LM248079
- G39** Bianco Soft LG248039
- G68** Bianco LG248068
- G59** Antracite LG248059
- G51** Avena LG248051
- G62** Bianco Antico LG248062

Life COLLECTION

Life 475 new

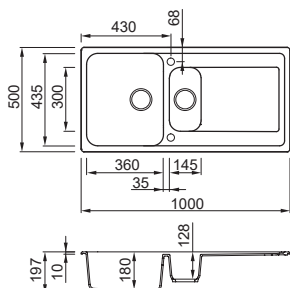

LAVELLO 2 VASCHE CON GOCCIOLATOIO

Dimensioni	1000 x 500 mm
Base	600 mm
Foro da incasso	980 x 480 mm
Profondità vasca	180 mm e 128 mm
Banco rubinetteria	Si
Installazione	Sopratop
Orientamento	Reversibile

GRANITEK

€ 400

- G40 Nero LG247540
- G78 Espresso LG247578
- G48 Cemento LG247548
- G43 Tortora LG247543
- M79 Nuvola LM247579
- G39 Bianco Soft LG247539
- G68 Bianco LG247568
- G59 Antracite LG247559
- G51 Avena LG247551
- G62 Bianco Antico LG247562

Life 410

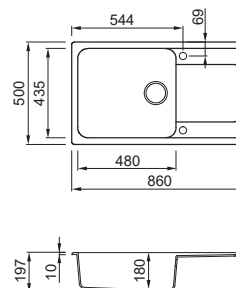

LAVELLO 1 VASCA CON GOCCIOLATOIO

Dimensioni	860 x 500 mm
Base	600 mm
Foro da incasso	840 x 480 mm
Profondità vasca	180 mm
Banco rubinetteria	Si
Installazione	Sopratop
Orientamento	Reversibile

GRANITEK

€ 390

- G40 Nero LG241040
- G78 Espresso LG241078
- G48 Cemento LG241048
- G43 Tortora LG241043
- M79 Nuvola LM241079
- G39 Bianco Soft LG241039
- G68 Bianco LG241068
- G59 Antracite LG241059
- G51 Avena LG241051
- G62 Bianco Antico LG241062

Life COLLECTION

Life 450

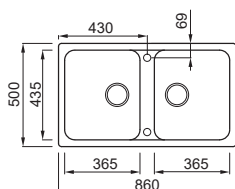
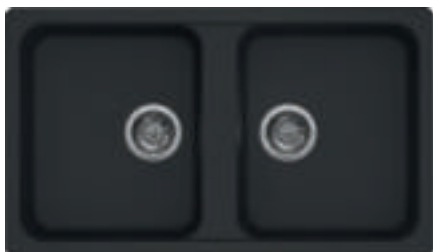

Life 400

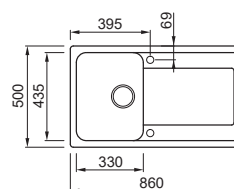
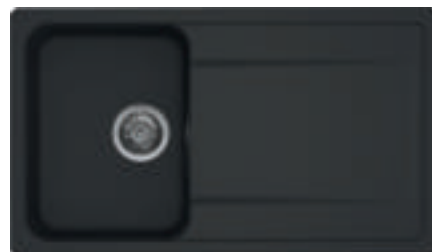

LAVELLO 2 VASCHE

Dimensioni	860 x 500 mm
Base	900 mm
Foro da incasso	840 x 480 mm
Profondità vasca	180 mm e 180 mm
Banco rubinetteria	Si
Installazione	Sopratop
Orientamento	Reversibile

GRANITEK

€ 370

- G40** Nero LG245040
- G78** Espresso LG245078
- G48** Cemento LG245048
- G43** Tortora LG245043
- M79** Nuvola LM245079
- G39** Bianco Soft LG245039
- G68** Bianco LG245068
- G59** Antracite LG245059
- G51** Avena LG245051
- G62** Bianco Antico LG245062

LAVELLO 1 VASCA CON GOCCIOLATOIO

Dimensioni	860 x 500 mm
Base	450 mm
Foro da incasso	840 x 480 mm
Profondità vasca	180 mm
Banco rubinetteria	Si
Installazione	Sopratop
Orientamento	Reversibile

GRANITEK

€ 350

- G40** Nero LG240040
- G78** Espresso LG240078
- G48** Cemento LG240048
- G43** Tortora LG240043
- M79** Nuvola LM240079
- G39** Bianco Soft LG240039
- G68** Bianco LG240068
- G59** Antracite LG240059
- G51** Avena LG240051
- G62** Bianco Antico LG240062

Life COLLECTION

Life 310 **new**

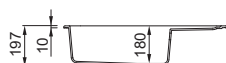
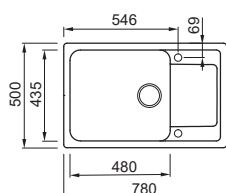

LAVELLO 1 VASCA CON GOCCIOLATOIO

Dimensioni	780 x 500 mm
Base	600 mm
Foro da incasso	760 x 480 mm
Profondità vasca	180 mm
Banco rubinetteria	Si
Installazione	Sopratop
Orientamento	Reversibile

GRANITEK

€ 380

- G40** Nero LG231040
- G78** Espresso LG231078
- G48** Cemento LG231048
- G43** Tortora LG231043
- M79** Nuvola LM231079
- G39** Bianco Soft LG231039
- G68** Bianco LG231068
- G59** Antracite LG231059
- G51** Avena LG231051
- G62** Bianco Antico LG231062

Life 300

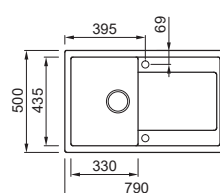

LAVELLO 1 VASCA CON GOCCIOLATOIO

Dimensioni	790 x 500 mm
Base	450 mm
Foro da incasso	770 x 480 mm
Profondità vasca	180 mm
Banco rubinetteria	Si
Installazione	Sopratop
Orientamento	Reversibile

GRANITEK

€ 350

- G40** Nero LG230040
- G78** Espresso LG230078
- G48** Cemento LG230048
- G43** Tortora LG230043
- M79** Nuvola LM230079
- G39** Bianco Soft LG230039
- G68** Bianco LG230068
- G59** Antracite LG230059
- G51** Avena LG230051
- G62** Bianco Antico LG230062

Life COLLECTION

IDEE DI STILE

Cloud



Caratteristiche tecniche ed altre finiture a pag. 193

● G 43 Tortora
MGKCLO43 € 255

COMPATIBILITÀ ACCESSORI LAVELLO

CHOPPING BOARD SLIDING 50



● BK Black
ATH010BK € 130
● QU Quercia
ATH010QU € 130

DRAINER FLEX 500

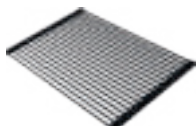

● BK Black
ARS023BK € 90
● GR Grey
ARS023GR € 90

TUTTI I MODELLI

MODELLI 500, 480, 410, 450, 475, 310

POD 250



● BK Black
APS250BK € 80
● GR Grey
APS250GR € 80

DRAIN SYSTEM

BASE OPEN UP



● IN Inox
KITASP-A-1VTELL-IN € 45
● BK Black
KITASP-A-1VTELL-BK € 90

TUTTI I MODELLI

ELLECI ZERO



Serie 60
TDZ060GR € 380
Serie 100
TDZ100GR € 450

TUTTI I MODELLI

Life

COLLECTION

Lavello Life 410 - G48 Cemento
Miscelatore Cloud - G48 Cemento
Forno Plano - G48 Cemento
Piano cottura Style 60 - G48 Cemento



Master

COLLECTION

Master è il lavello dal fascino country, genuino e senza tempo. Il suo design, caratterizzato da un ampio bacino e linee morbide, evoca la bellezza delle tradizioni. Una collezione dedicata a chi in cucina vuole calore e familiarità.

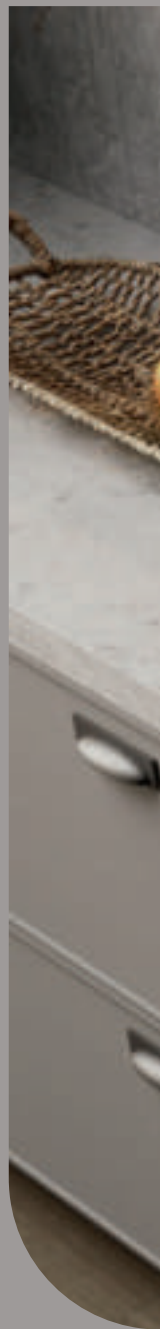
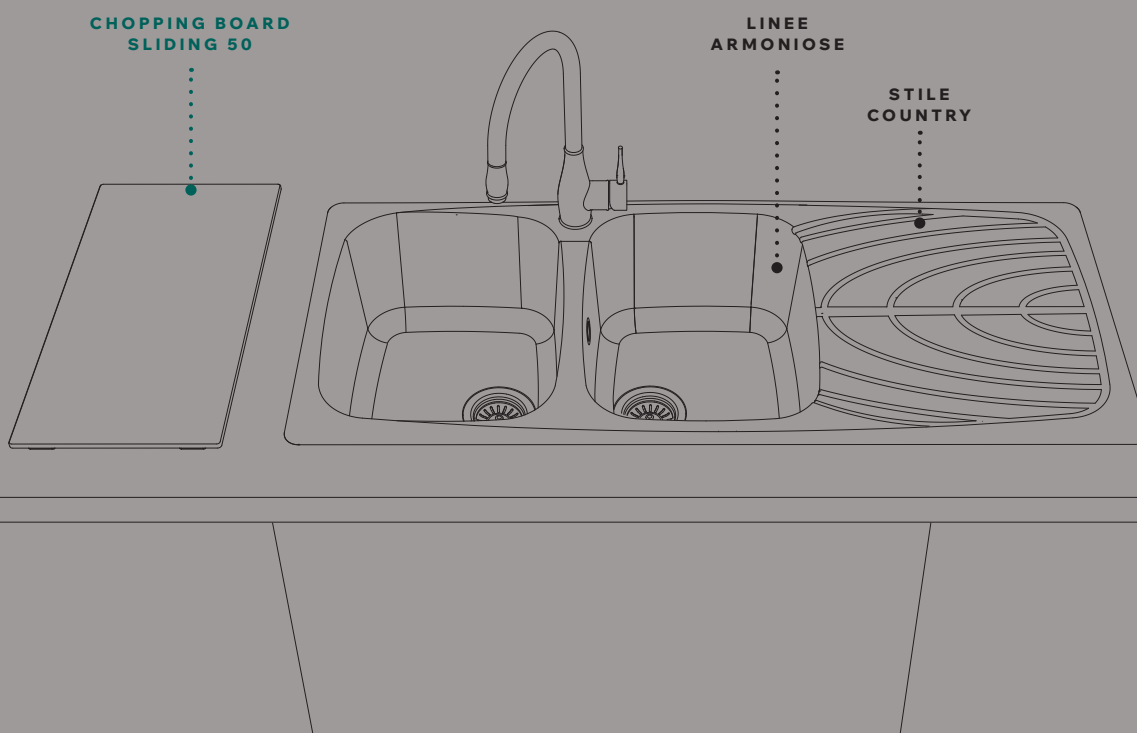

MODELLI MASTER

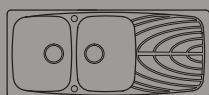

Master 500

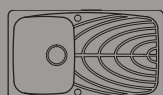

Master 400

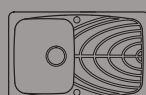

Master 300



Master 450



Master 350



Lavello Master 500 - G51 Avena
Miscelatore Neva - G51 Avena

GRANITEK

G40
NERO

G68
BIANCO

G59
ANTRACITE

G51
AVENA

G62
BIANCO
ANTICO

Master COLLECTION

Master 500

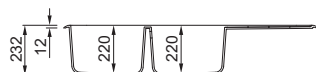
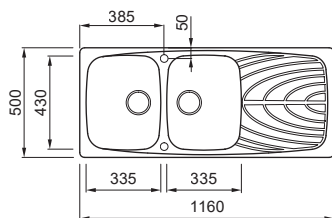

LAVELLO 2 VASCHE CON GOCCIOLATOIO

Dimensioni	1160 x 500 mm
Base	800 mm
Foro da incasso	1140 x 480 mm
Profondità vasca	220 mm e 220mm
Banco rubinetteria	Si
Installazione	Sopratop
Orientamento	Reversibile

GRANITEK

€ 430

- G40 Nero LGM50040
- G68 Bianco LGM50068
- G59 Antracite LGM50059
- G51 Avena LGM50051
- G62 Bianco Antico LGM50062

Master 400

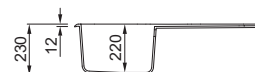
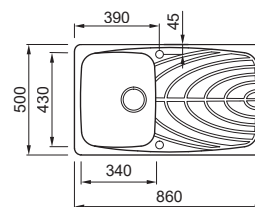

LAVELLO 1 VASCA CON GOCCIOLATOIO

Dimensioni	860 x 500 mm
Base	450 mm
Foro da incasso	840 x 480 mm
Profondità vasca	220 mm
Banco rubinetteria	Si
Installazione	Sopratop
Orientamento	Reversibile

GRANITEK

€ 370

- G40 Nero LGM40040
- G68 Bianco LGM40068
- G59 Antracite LGM40059
- G51 Avena LGM40051
- G62 Bianco Antico LGM40062

Master COLLECTION

Master 300

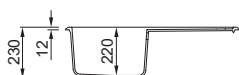
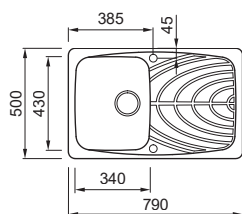

LAVELLO 1 VASCA CON GOCCIOLATOIO

Dimensioni	790 x 500 mm
Base	450
Foro da incasso	770 x 480 mm
Profondità vasca	220 mm
Banco rubinetteria	Si
Installazione	Sopratop
Orientamento	Reversibile

GRANITEK

€ 370

- G40 Nero LGM30040
- G68 Bianco LGM30068
- G59 Antracite LGM30059
- G51 Avena LGM30051
- G62 Bianco Antico LGM30062

Master 450

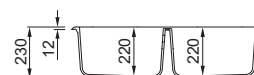
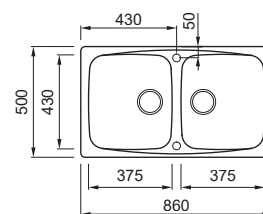

LAVELLO 2 VASCHE

Dimensioni	860 x 500 mm
Base	900 mm
Foro da incasso	840 x 480 mm
Profondità vasca	220 mm
Banco rubinetteria	Si
Installazione	Sopratop
Orientamento	Reversibile

GRANITEK

€ 400

- G40 Nero LGM45040
- G68 Bianco LGM45068
- G59 Antracite LGM45059
- G51 Avena LGM45051
- G62 Bianco Antico LGM45062

Master COLLECTION

Master 350

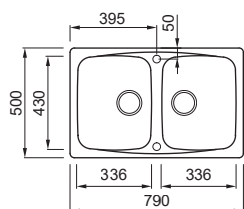

LAVELLO 2 VASCHE

Dimensioni	790 x 500 mm
Base	800 900 mm se inizio composizione
Foro da incasso	770 x 480 mm
Profondità vasca	220 mm e 220mm
Banco rubinetteria	Si
Installazione	Sopratop
Orientamento	Reversibile

GRANITEK

€ 400

- G40 Nero
LGM35040
- G68 Bianco
LGM35068
- G59 Antracite
LGM35059
- G51 Avena
LGM35051
- G62 Bianco Antico
LGM35062

Master COLLECTION

IDEE DI STILE

Neva



Caratteristiche tecniche ed altre finiture a pag. 190

G 68 Bianco
MGKNEV68 € 280

DRAIN SYSTEM

BASE OPEN UP



IN Inox
KITASP-A-1VTELL-IN € 45
BK Black
KITASP-A-1VTELL-BK € 90

TUTTI I MODELLI

ELLECI ZERO



Serie 60
TDZ060GR € 380
Serie 100
TDZ100GR € 450

TUTTI I MODELLI

COMPATIBILITÀ ACCESSORI LAVELLO

CHOPPING BOARD
SLIDING 50



BK Black
ATH010BK € 130
QU Quercia
ATH010QU € 130

DRAINER FLEX
500

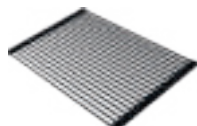

BK Black
ARS023BK € 90
GR Grey
ARS023GR € 90

TUTTI I MODELLI

TUTTI I MODELLI

TUTTI I MODELLI

POD 250



BK Black
APS250BK € 80
GR Grey
APS250GR € 80

Lavelli Inox

COLLECTION



COMPASS

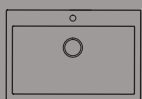

Compass 700



Compass 650
new

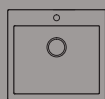

Compass 500



Compass 400



ESPRIT



Esprit 700



Esprit 650
new



Esprit 500



Esprit 400



W-SQUARE



W-Square 700



W-Square 500



W-Square 400



SKY

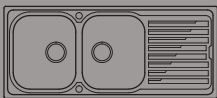

Sky 500

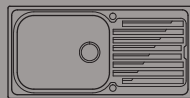

Sky 480

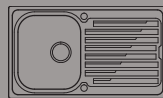

Sky 400

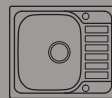

Sky 125

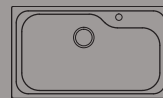

Sky 360

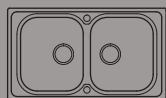

Sky 450



SkyRound

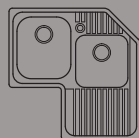

Sky Corner



Lavello Compass 700 - IN Inox
Miscelatore Stream Plus - CR Cromo

INOX



I lavelli Inox esprimono una sensibilità estetica senza tempo. Ogni collezione si distingue per un tratto unico: il banco rubinetteria integrato di Compass, le linee essenziali di Esprit, lo Square Drain System di W-Square e la grande versatilità di Sky.

Inox

COLLECTION

L'acciaio satinato riflette la luce in modo morbido e uniforme, la finitura opaca ne esalta il carattere moderno. Resistente a graffi, macchie e usura, garantisce massima igiene e conserva inalterata la sua bellezza.





TUTTE LE COLLEZIONI DIALOGANO CON UN SET DI ACCESSORI DEDICATI

Compass COLLECTION

Compass 700

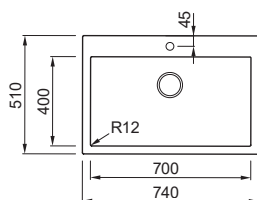

LAVELLO 1 VASCA IN ACCIAIO INOX SP. 10/10

Dimensioni	740 x 510 mm
Base	800 mm
Foro da incasso	730 x 495 mm R10 (Sopratop)
Foro da incasso	Vedi disegno sotto (Filotop)
Profondità vasca	200 mm
Banco rubinetteria	Si
Installazione	Sopratop Filotop

INOX

€ 620

IN INOX SATINATO AISI 304
LIM700SAC

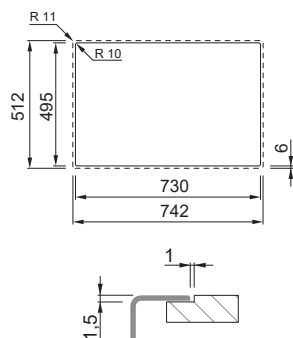

Compass 650 **new**



base
75

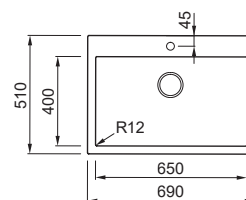

LAVELLO 1 VASCA IN ACCIAIO INOX SP. 10/10

Dimensioni	690 x 510 mm
Base	750 mm
Foro da incasso	680 x 495 mm R10 (Sopratop)
Foro da incasso	Vedi disegno sotto (Filotop)
Profondità vasca	200 mm
Banco rubinetteria	Si
Installazione	Sopratop Filotop

INOX

€ 610

IN INOX SATINATO AISI 304
LIM650SAC

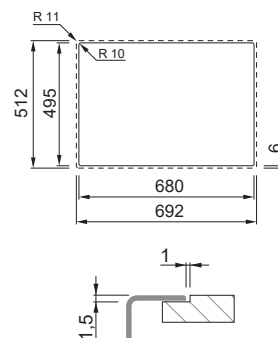

Compass COLLECTION

Compass 500

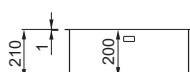
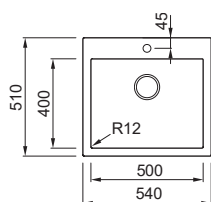

LAVELLO 1 VASCA IN ACCIAIO INOX SP. 10/10

Dimensioni	540 x 510 mm
Base	600 mm
Foro da incasso	530 x 495 mm R10 (Sopratop)
Foro da incasso	Vedi disegno sotto (Filotop)
Profondità vasca	200 mm
Banco rubinetteria	Si
Installazione	Sopratop Filotop

INOX

€ 580

IN

INOX SATINATO AISI 304
LIM500SAC

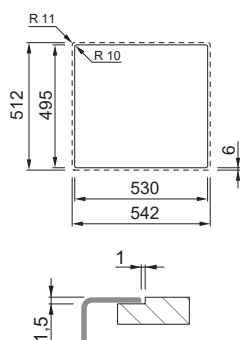

Compass 400

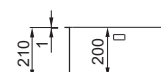
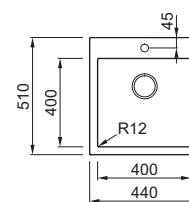

LAVELLO 1 VASCA IN ACCIAIO INOX SP. 10/10

Dimensioni	440 x 510 mm
Base	500 mm
Foro da incasso	430 x 495 mm R10 (Sopratop)
Foro da incasso	Vedi disegno sotto (Filotop)
Profondità vasca	200 mm
Banco rubinetteria	Si
Installazione	Sopratop Filotop

INOX

€ 550

IN

INOX SATINATO AISI 304
LIM400SAC

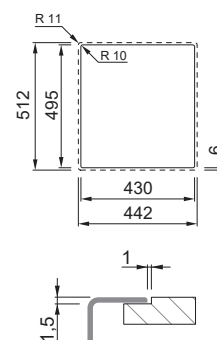

Esprit COLLECTION

Esprit 700

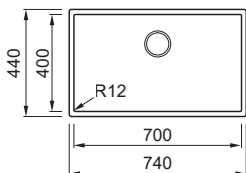

LAVELLO 1 VASCA IN ACCIAIO INOX SP. 10/10

Dimensioni	740 x 440 mm
Base	800 mm
Foro da incasso	730 x 430 mm R10 (Sopratop)
Foro da incasso	701 x 401 mm R13 (Sottotop)
Foro da incasso	Vedi disegno sotto (Filotop)
Profondità vasca	200 mm
Banco rubinetteria	Si
Installazione	Sopratop Sottotop Filotop

INOX

€ 510

IN INOX SATINATO AISI 304
LIE700SAC

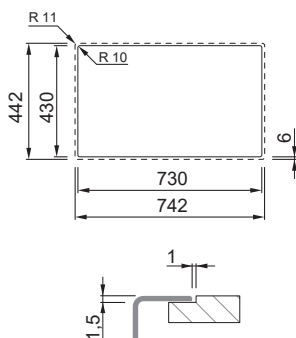

Esprit 650

new



base
75

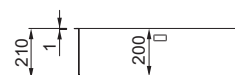
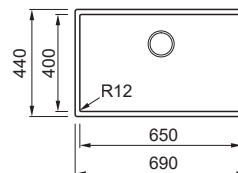

LAVELLO 1 VASCA IN ACCIAIO INOX SP. 10/10

Dimensioni	690 x 440 mm
Base	750 mm
Foro da incasso	680 x 430 mm R10 (Sopratop)
Foro da incasso	651 x 401 mm R13 (Sottotop)
Foro da incasso	Vedi disegno sotto (Filotop)
Profondità vasca	200 mm
Banco rubinetteria	Si
Installazione	Sopratop Sottotop Filotop

INOX

€ 500

IN INOX SATINATO AISI 304
LIE650SAC

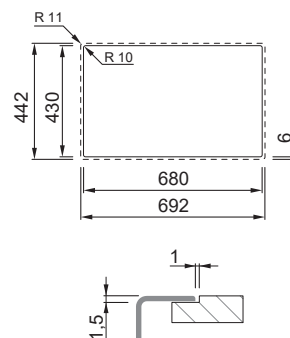

Esprit COLLECTION

Esprit 500

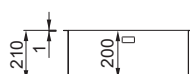
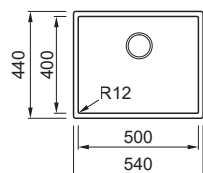

LAVELLO 1 VASCA IN ACCIAIO INOX SP. 10/10

Dimensioni	540 x 440 mm
Base	600 mm
Foro da incasso	530 x 430 mm R10 (Sopratop)
Foro da incasso	501 x 401 mm R13 (Sottotop)
Foro da incasso	Vedi disegno sotto (Filotop)
Profondità vasca	200 mm
Banco rubinetteria	Si
Installazione	Sopratop Sottotop Filotop

INOX

€ 450

IN

INOX SATINATO AISI 304
LIE500SAC

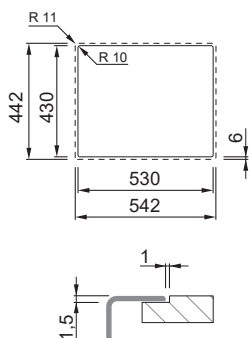

Esprit 400

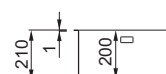
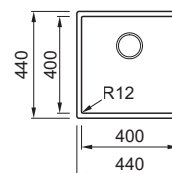

LAVELLO 1 VASCA IN ACCIAIO INOX SP. 10/10

Dimensioni	440 x 440 mm
Base	500 mm (Sopratop Sottotop Filotop)
Foro da incasso	430 x 430 mm R10 (Sopratop)
Foro da incasso	401 x 401 mm R13 (Sottotop)
Foro da incasso	Vedi disegno sotto (Filotop)
Profondità vasca	200 mm
Banco rubinetteria	Si
Installazione	Sopratop Sottotop Filotop

INOX

€ 430

IN

INOX SATINATO AISI 304
LIE400SAC

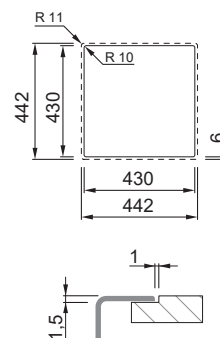

W-Square COLLECTION

W-Square 700

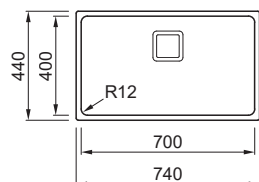

LAVELLO 1 VASCA IN ACCIAIO INOX SP. 10/10

Dimensioni	740 x 440 mm R12
Base	800 mm
Foro da incasso	730 x 430 mm R10 (Sopratop)
Foro da incasso	701 x 401 mm R13 (Sottotop)
Foro da incasso	Vedi disegno sotto (Filotop)
Profondità vasca	200 mm
Banco rubinetteria	Si
Installazione	Sopratop Sottotop Filotop

INOX

€ 510

IN INOX SATINATO AISI 304
LIW700SACMU

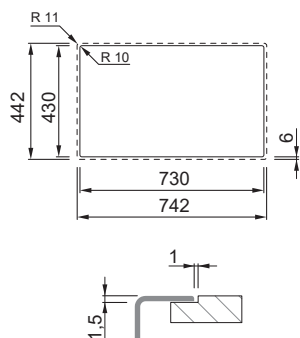

W-Square 500

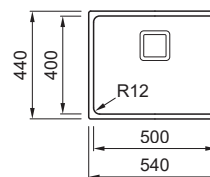

LAVELLO 1 VASCA IN ACCIAIO INOX SP. 10/10

Dimensioni	540 x 440 mm R12
Base	600 mm
Foro da incasso	530 x 430 mm R10 (Sopratop)
Foro da incasso	501 x 401 mm R13 (Sottotop)
Foro da incasso	Vedi disegno sotto (Filotop)
Profondità vasca	200 mm
Banco rubinetteria	Si
Installazione	Sopratop Sottotop Filotop

INOX

€ 420

IN INOX SATINATO AISI 304
LIW500SACMU

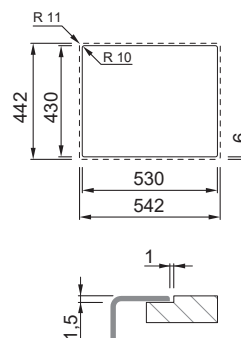

W-Square COLLECTION

W-Square 400

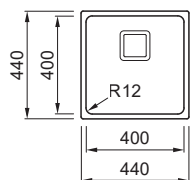

LAVELLO 1 VASCA IN ACCIAIO INOX SP. 10/10

Dimensioni	440 x 440 mm R12
Base	450 mm (Sopratop Sottotop) 600 mm (Filotop)
Foro da incasso	430 x 430 mm R10 (Sopratop)
Foro da incasso	401 x 401 mm R13 (Sottotop)
Foro da incasso	Vedi disegno sotto (Filotop)
Profondità vasca	200 mm
Banco rubinetteria	Si
Installazione	Sopratop Sottotop Filotop

INOX

€ 360

IN

INOX SATINATO AISI 304
LIW400SACMU

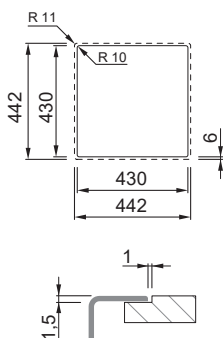

Sky COLLECTION

Sky 500

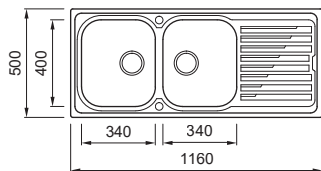

LAVELLO 2 VASCHE CON GOCCIOLATOIO IN ACCIAIO INOX SP. 6/10

Dimensioni	1160 x 500 mm
Base	800 mm
Foro da incasso	1140 x 480 mm
Profondità vasca	180 mm e 180 mm
Banco rubinetteria	Si
Installazione	Sopratop
Orientamento	Non reversibile

INOX

€ 310

IN INOX SATINATO AISI 304
LIK500SACDX
LIK500SACSX

Sky 480

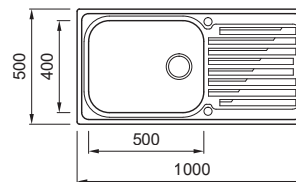

LAVELLO 1 VASCA CON GOCCIOLATOIO IN ACCIAIO INOX SP. 6/10

Dimensioni	1000 x 500 mm
Base	600 mm
Foro da incasso	980 x 480 mm
Profondità vasca	205 mm
Banco rubinetteria	Si
Installazione	Sopratop
Orientamento	Non reversibile

INOX

€ 300

IN INOX SATINATO AISI 304
LIK480SACDX
LIK480SACSX

Sky COLLECTION

Sky 400

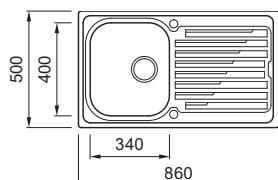

LAVELLO 1 VASCA CON GOCCIOLATOIO IN ACCIAIO INOX SP. 6/10

Dimensioni	860 x 500 mm
Base	450 mm
Foro da incasso	840 x 480 mm
Profondità vasca	180 mm
Banco rubinetteria	Si
Installazione	Sopratop
Orientamento	Non reversibile

INOX

€ 230

IN

INOX SATINATO AISI 304
LIK400SACDX
LIK400SACSX

Sky 125

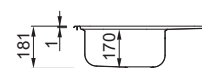
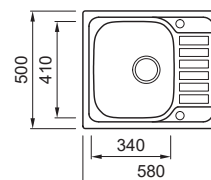

LAVELLO 1 VASCA CON GOCCIOLATOIO IN ACCIAIO INOX SP. 6/10

Dimensioni	580 x 500 mm
Base	450 mm
Foro da incasso	560 x 480 mm
Profondità vasca	170 mm
Banco rubinetteria	Si
Installazione	Sopratop
Orientamento	Non reversibile

INOX

€ 130

IN

INOX SATINATO AISI 304
LIK125SACDX
LIK125SACSX

Sky COLLECTION

Sky 360

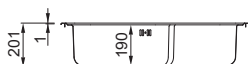
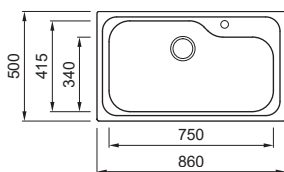

LAVELLO 1 VASCA IN ACCIAIO INOX SP. 6/10

Dimensioni	860 x 500 mm
Base	900 mm
Foro da incasso	840 x 480 mm
Profondità vasca	190 mm
Banco rubinetteria	Si
Installazione	Sopratop
Orientamento	Non reversibile

INOX

€ 380

IN

INOX SATINATO AISI 304
LIK360SAC

Sky 450

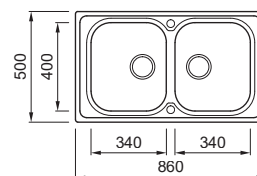

LAVELLO 2 VASCHE IN ACCIAIO INOX SP. 6/10

Dimensioni	860 x 500 mm
Base	800 900 mm se inizio composizione
Foro da incasso	840 x 480 mm
Profondità vasca	180 mm e 180 mm
Banco rubinetteria	Si
Installazione	Sopratop
Orientamento	Reversibile

INOX

€ 280

IN

INOX SATINATO AISI 304
LIK450SAC

Sky COLLECTION

Sky Round

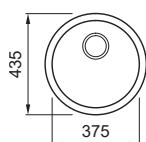

LAVELLO 1 VASCA IN ACCIAIO INOX SP. 6/10

Dimensioni	Ø 435 mm
Base	450 mm
Foro da incasso	Ø 415 mm
Profondità vasca	160 mm
Banco rubinetteria	Si
Installazione	Sopratop
Orientamento	Non reversibile

INOX

€ 120

IN

INOX SATINATO AISI 304
LIKROUSAC

Sky Corner

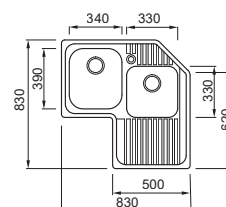

LAVELLO 2 VASCHE CON GOCCIOLATOIO IN ACCIAIO INOX SP. 6/10

Dimensioni	830 x 830 mm
Base	Angolo
Foro da incasso	Da dima*
Profondità vasca	210 mm e 200 mm
Banco rubinetteria	Si
Installazione	Sopratop
Orientamento	Non reversibile

INOX

€ 780

IN

INOX SATINATO AISI 304
LIKORSACDX
LIKORSACSX

Accessori LAVELLI INOX

ACCESSORI LAVELLO COMPASS

CHOPPING BOARD
418



- BK Black
ATH043BK € 110
- WD Wood
ATH043WD € 110

DRAINER FLEX
440

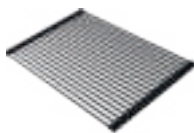

- BK Black
ARS013BK € 80
- GR Grey
ARS013GR € 80

COLANDER
418



- BK Black
AVP035BK € 65

ACCESSORI LAVELLO ESPRIT

CHOPPING BOARD
418



- BK Black
ATH043BK € 110
- WD Wood
ATH043WD € 110

DRAINER FLEX
440

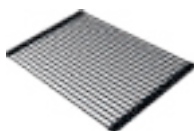

- BK Black
ARS013BK € 80
- GR Grey
ARS013GR € 80

COLANDER
418



- BK Black
AVP035BK € 65

ACCESSORI LAVELLO W-SQUARE

CHOPPING BOARD
418



- BK Black
ATH043BK € 110
- WD Wood
ATH043WD € 110

DRAINER FLEX
440

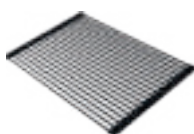

- BK Black
ARS013BK € 80
- GR Grey
ARS013GR € 80

COLANDER
418



- BK Black
AVP035BK € 65

ACCESSORI LAVELLO SKY

CHOPPING BOARD
SLIDING 50



- BK Black
ATH010BK € 130
- QU Quercia
ATH010QU € 130

DRAINER FLEX
500

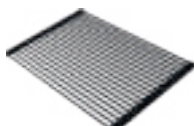

- BK Black
ARS023BK € 90
- GR Grey
ARS023GR € 90

SMART AREA

ELLECI ZERO



- Serie 60
TDZ060GR € 380
- Serie 100
TDZ100GR € 450

TUTTI I MODELLI

FLANGIA DISSIPATORE
PILETTA QUADRATA



- ATQ01300 € 38

Nota:
Accessorio necessario per l'installazione del
dissipatore con tutti i lavelli W-Square

MODELLI W-SQUARE

Accessori LAVELLI INOX



Accessori

Crea la tua workstation

Dai forma all'area di preparazione ideale con accessori pensati per ogni gesto: taglia con precisione, appoggia con sicurezza, scola con praticità, pulisci con facilità e organizza con stile. Massima funzionalità, zero sprechi di spazio.





Accessori

CHOPPING BOARD SPAZIO

Tagliere in Woodtech / HPL
Dimensioni: 455 x 253 x 9 mm

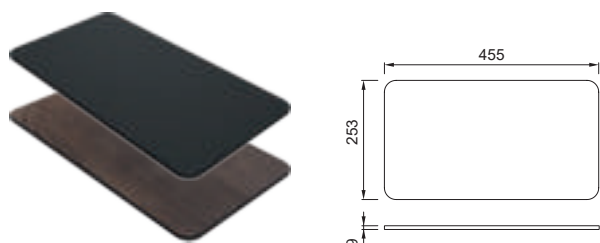

- BK Black
ATH123BK € 100
- WD Wood
ATH123WD € 100

SPAZIO

CHOPPING BOARD SLIDING 50

Tagliere in Woodtech / HPL
Dimensioni: 540 x 280 x 8 mm

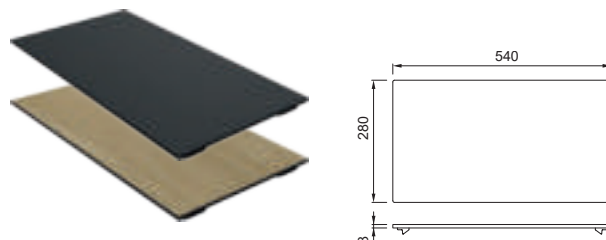

- BK Black
ATH010BK € 130
- QU Quercia
ATH010QU € 130

KARISMA, LIFE, UNICO, EASY, EGO, MASTER

CHOPPING BOARD BEST LINE

Tagliere in Woodtech / HPL
Dimensioni: 445 x 280 x 8 mm

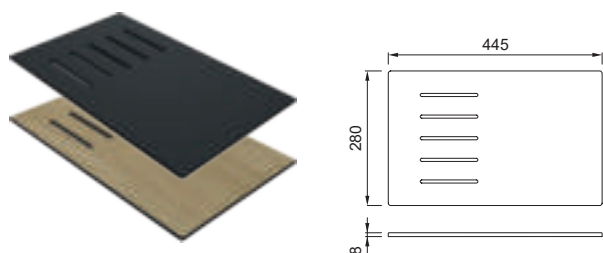

- BK Black
ATH020BK € 110
- QU Quercia
ATH020QU € 110

BEST

CHOPPING BOARD BEST WORKSTATION

Tagliere in Woodtech / HPL
Dimensioni: 383 x 339 x 8 mm

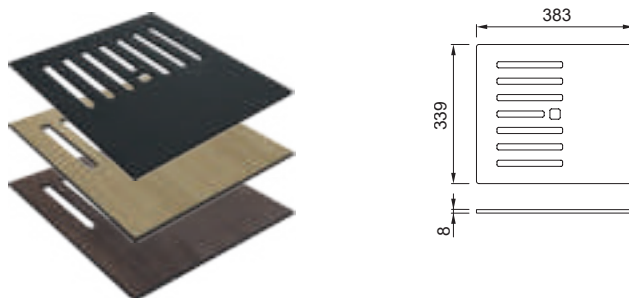

- BK Black
ATH073BK € 115
- QU Quercia
ATH073QU € 115
- WD Wood
ATH073WD € 115

BEST WORKSTATION

Accessori

CHOPPING BOARD 380

Tagliere in Woodtech / HPL
Dimensioni: 380 x 220 x 8 mm

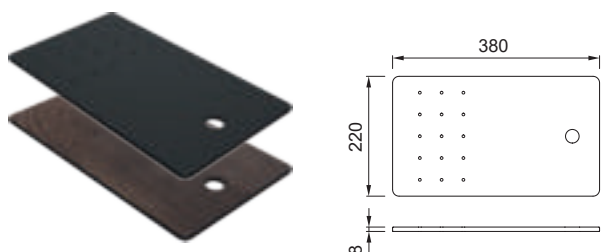

- BK Black ATH143BK € 90
- WD Wood ATH143WD € 90

TIME E TIME UNDERMOUNT

CHOPPING BOARD 418

Tagliere in Woodtech / HPL
Dimensioni: 418 x 280 x 8 mm

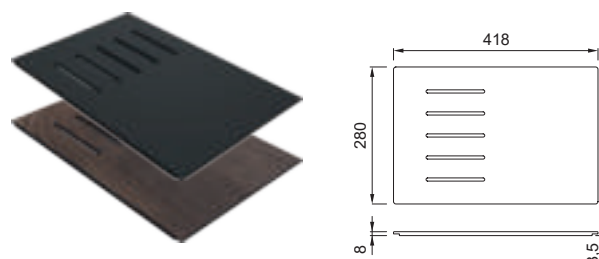

- BK Black ATH043BK € 110
- WD Wood ATH043WD € 110

ZEN, QUADRA, W-SQUARE, COMPASS, ESPRIT, ZEN-F

CHOPPING BOARD FOX 360

Tagliere in Woodtech
Dimensioni: 435 x 285 x 6,4 mm

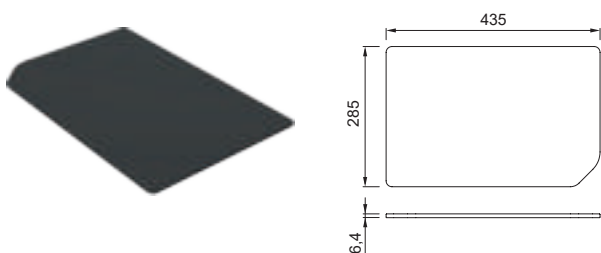

- BK Black ATH153BK € 120

FOX

CHOPPING BOARD FOX 360

Tagliere in HPL con vaschetta
Dimensioni: 435 x 285 x 8 mm

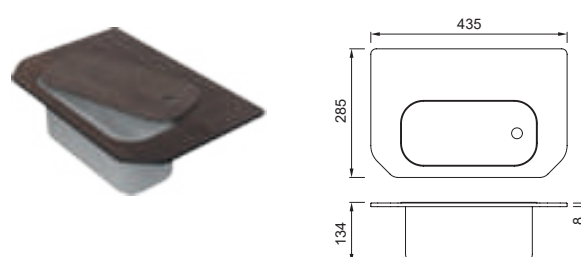

- WD Wood ATH153WD € 160

FOX

Accessori

DRAINER FLEX 500

Gocciolatoio flessibile con barre in acciaio rivestite in silicone
Dimensioni: 500 x 334 x 10 mm

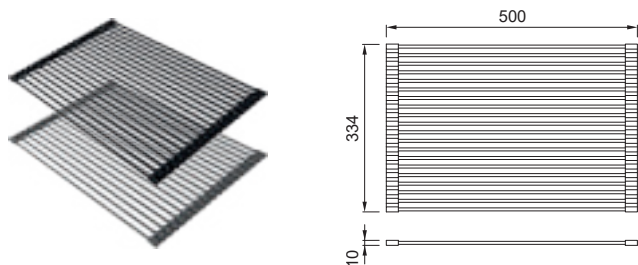

- BK Black
ARS023BK € 90
- GR Grey
ARS023GR € 90

BEST, BEST WORKSTATION, LIFE, UNICO, EGO, EASY, MASTER

DRAINER FLEX 440

Gocciolatoio flessibile con barre in acciaio rivestite in silicone
Dimensioni: 440 x 300 x 10 mm

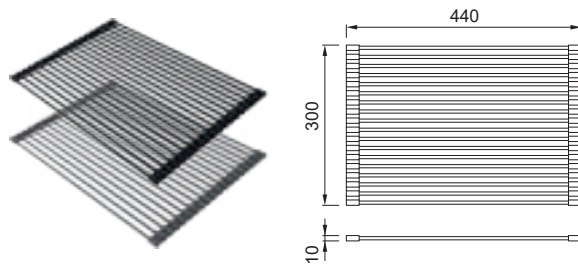

- BK Black
ARS013BK € 80
- GR Grey
ARS013GR € 80

QUADRA, QUADRA SOTTOTOP, KARISMA, ZEN E ZEN F

SOAP DISPENSER TONDO

Dosatore sapone in metallo
Foro di incasso - \varnothing 35 mm
Dimensioni - \varnothing 39 mm

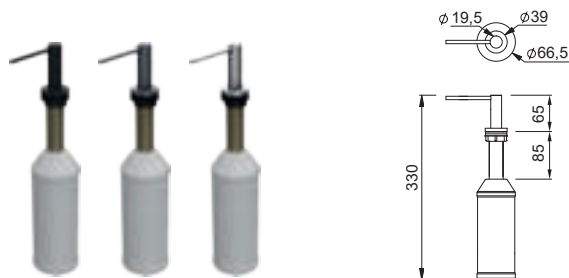

- BK Black
ADI02304BK € 70
- GM Gun metal
ADI02304GM € 70
- CR Cromo
ADI02304CR € 60

SPAZIO, BEST W, KARISMA, TIME, QUADRA, UNICO, EASY, FOX

SOAP DISPENSER QUADRATO

Dosatore sapone in metallo
Foro di incasso - \varnothing 35 mm
Dimensioni - 40 x 40 mm

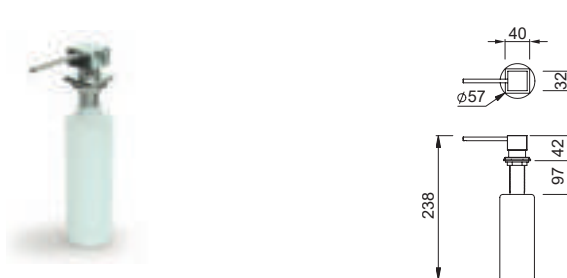

- CR Cromo
ADI02301 € 100

SPAZIO, BEST W, KARISMA, TIME, QUADRA, UNICO, EASY, FOX

Accessori

COLANDER 380

new

Vasca forata in polipropilene
Dimensioni: 380 x 165 x 86 mm

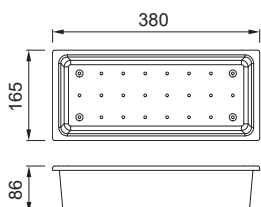

- BK Black AVP038BK € 65
- GR Grey AVP038GR € 65

BEST WORKSTATION, TIME, TIME UNDERMOUNT

BOWL 380

new

Vasca chiusa in polipropilene
Dimensioni: 380 x 165 x 86 mm

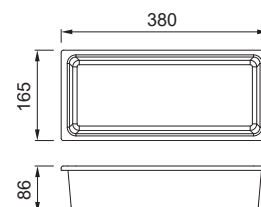

- BK Black ABP038BK € 65
- GR Grey ABP038GR € 65

BEST WORKSTATION, TIME, TIME UNDERMOUNT

COLANDER 418

Vasca forata in polipropilene
Dimensioni: 418 x 138 x 84 mm

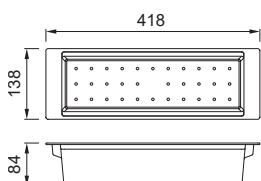
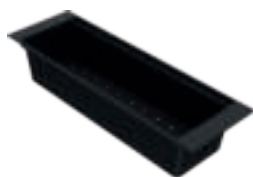

- BK Black AVP035BK € 65

ZEN, ZEN F, QUADRA

POD 250

new

Contenitore multiuso in silicone
Dimensioni: 250 x 250 x 150 mm

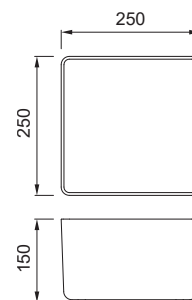

- BK Black APS250BK € 80
- GR Grey APS250GR € 80

TUTTI I MODELLI

Drain system

FLOW PRO SYSTEM

Sistema di scarico 1 via Flow Pro con troppopieno rettangolare



- BK Black
KITWPT-F-1VSELL-BK € 115
- GM Gun metal
KITWPT-F-1VSELL-GM € 100
- IN Inox
KITWPT-F-1VSELL-IN € 50

BEST, BEST WORKSTATION, SPAZIO, ZEN, ZEN F

FLOW PRO OPEN UP

Sistema automatico di scarico 1 via Flow Pro con troppopieno rettangolare e comando remoto Open Up

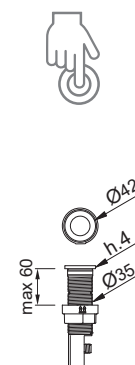

- BK Black
KITASP-F-1VSELL-BK € 150
- GM Gun metal
KITASP-F-1VSELL-GM € 150
- IN Inox
KITASP-F-1VSELL-IN € 80

BEST, BEST WORKSTATION, SPAZIO

FLOW PRO OPEN TWIST

Sistema automatico di scarico 1 via Flow Pro con troppopieno rettangolare e comando remoto Open Twist

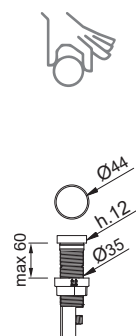

- BK Black
KITASPT-F-1VSELL-BK € 150
- IN Inox
KITASPT-F-1VSELL-IN € 80

BEST, BEST WORKSTATION, SPAZIO

Drain system

FLOW SYSTEM

Sistema di scarico 1 via Flow con troppopieno tondo



- BK Black
KITWPT-FB-1VTELL-BK € 35
- IN Inox
KITWPT-FB-1VTELL-IN € 30

TIME, QUADRA, Q-SOTTOTOP, FOX, EASY, EGO, UNICO, LIFE, MASTER

FLOW OPEN UP

Sistema automatico di scarico 1 via Flow con troppopieno tondo e comando remoto Open Up

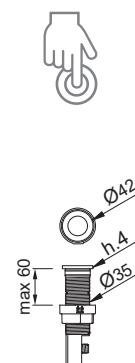

- BK Black
KITASP-FB-1VTELL-BK € 80
- IN Inox
KITASP-FB-1VTELL-IN € 70

TIME, UNICO, QUADRA, MASTER, FOX, EGO, EASY, LIFE

FLOW OPEN TWIST

Sistema automatico di scarico 1 via Flow con troppopieno tondo e comando remoto Open Twist

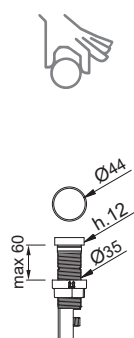

- BK Black
KITASPT-FB-1VTELL-BK € 80
- IN Inox
KITASPT-FB-1VTELL-IN € 70

TIME, UNICO, QUADRA, MASTER, FOX, EGO, EASY, LIFE

Drain system

GHOST SYSTEM

Sistema di scarico 1 via Flow con cover piletta e troppopieno tondo



- BK Black
KITWPT-FBC-1VTELL-BK € 45
- IN Inox
KITWPT-FBC-1VTELL-IN € 40

TIME UNDERMOUNT

GHOST OPEN UP

Sistema automatico di scarico 1 via Flow con cover piletta, troppopieno tondo e comando remoto Open Up



- BK Black
KITASP-FBC-1VTELL-BK € 90
- IN Inox
KITASP-FBC-1VTELL-IN € 80

Nota: installazione comando su top

TIME UNDERMOUNT

GHOST OPEN TWIST

Sistema di scarico 1 via Flow con cover piletta, troppopieno tondo e comando remoto Open Twist

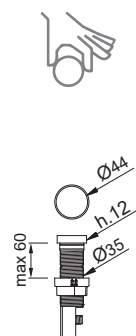

- BK Black
KITASPT-FBC-1VTELL-BK € 90
- IN Inox
KITASPT-FBC-1VTELL-IN € 80

Nota: installazione comando su top

TIME UNDERMOUNT

Drain system

BASE OPEN UP

Sistema automatico di scarico 1 via Base con troppopieno tondo e comando remoto Open Up



- BK Black
KITASP-A-1VTELL-BK € 90
- IN Inox
KITASP-A-1VTELL-IN € 45

QUADRA, LIFE, EASY, FOX, MASTER

SQUARE OPEN UP

Sistema automatico di scarico 1 via Square con troppopieno rettangolare e comando remoto Open Up



- IN Inox
KITASP-Q-1VSELL-IN € 70

KARISMA

Miscelatori

new
design

Chef

new

River

new

Nami

Wave

new

Kai

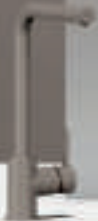

Trail
PLUS



Trail



Stream
PLUS



Tourmaline
PURE



Tourmaline
PLUS PURE

new



Ventum
PURE

new



Loch

new

new
design

Athena
PLUS

Athena

Cloud

Bridge



Dora
PLUS

Neva

Adige

Danubio

new
design



Reno

Sava

Taos

new



Minerva

Venere

Po

Rio

Senna

Finiture trendy, qualità che dura nel tempo e soluzioni sempre più orientate alla sostenibilità



Dalla moda al design, **Gun metal** è il colore di tendenza che unisce fascino industriale e raffinatezza contemporanea nei miscelatori professionali.



Comodità e funzionalità: la **doccetta** raggiunge ogni angolo del lavello, facilitando la pulizia. Il cambio getto regola il flusso d'acqua secondo necessità.



La selezione di miscelatori realizzati 100% in **acciaio inox** di alta qualità: naturalmente igienico, resistente ed ecosostenibile, con finitura satinata.



La leva in posizione centrale favorisce l'apertura con acqua fredda; la cartuccia a doppio scatto e l'erogatore a portata ridotta evitano gli sprechi involontari.

Filtrazione, una scelta responsabile e all'avanguardia

Scopri la collezione di miscelatori filtranti, abbinabili al nuovo sistema di filtrazione dell'acqua Elleci Pure, e trasforma il rubinetto della tua cucina in una fonte di acqua pulita, sicura e dal gusto piacevole. Con tanti benefici per te e per il pianeta.



Tourmaline PURE

Miscelatore filtrante tre vie doppio comando con canna girevole.

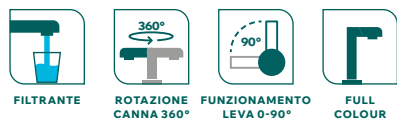

Comandi ed erogatori separati per acqua miscelata e acqua filtrata

CARATTERISTICHE

Base canna Ø 50 mm
 Rotazione canna 360°
 Funzionamento leva 0-90°
 Tipologia flessibile Inox 3/8" mm
 Lunghezza flessibile 400 mm
 Cartuccia Ø 35 mm
 Foro incasso Ø 35 mm

€ 310

● IN Inox spazzolato MIKTUOIN

€ 310

- K86 Black MKKTU86
- K96 White MKKTU96
- G40 Nero MGKTU40
- G68 Bianco MGKTU68
- G51 Avena MGKTU51

ELLECI PURE € 350

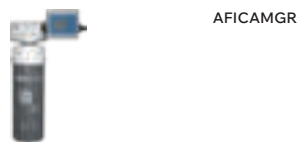

AFICAMGR

Tourmaline PLUS PURE new

Miscelatore filtrante tre vie doppio comando con canna girevole e doccetta estraibile.



Comandi ed erogatori separati per acqua miscelata e acqua filtrata

CARATTERISTICHE

Base canna Ø 50 mm
 Rotazione canna 360°
 Funzionamento leva 0-90°
 Tipologia flessibile Inox 3/8" mm
 Lunghezza flessibile 400 mm
 Cartuccia Ø 35 mm
 Foro incasso Ø 35 mm

€ 360

● IN Inox spazzolato MIKTOPIN

€ 360

- K86 Black MKKTOP86
- K96 White MKKTOP96
- G40 Nero MGKTOP40
- G68 Bianco MGKTOP68
- G51 Avena MGKTOP51

ELLECI PURE € 350



AFICAMGR

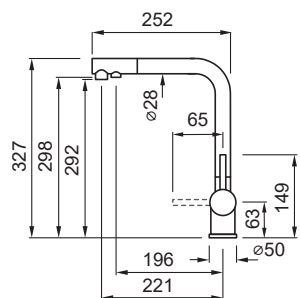

INOX AISI304 Realizzato completamente in Acciaio Inox AISI304

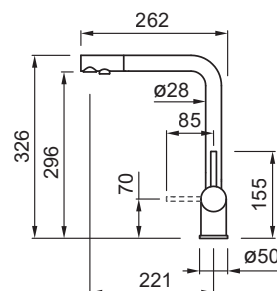

INOX AISI304 Realizzato completamente in Acciaio Inox AISI304

Ventum PURE new

Miscelatore filtrante tre vie doppio comando con canna alta in silicone, doccetta orientabile doppio getto e braccio girevole per erogazione acqua filtrata.

CARATTERISTICHE

Base canna Ø 53 mm
 Rotazione canna 360°
 Funzionamento leva 0-90°
 Tipologia flessibile
 Lunghezza flessibile 400 mm
 Cartuccia Ø 35 mm
 Foro incasso Ø 35 mm

€ 420



CR Cromo

MIKVNTCR

€ 440



BK Black

MOKVNTBK

ELLECI PURE

€ 350



AFICAMGR

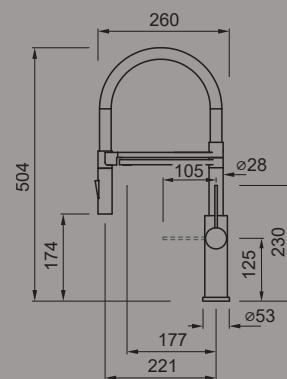

Comandi ed erogatori separati per acqua miscelata e acqua filtrata



FILTRANTE



ROTAZIONE
CANNA 360°



FUNZIONAMENTO
LEVA 0-90°

elleci pure

Acqua pura, gusto naturale e rispetto per l'ambiente

Immagina di aprire il miscelatore in cucina e avere sempre a disposizione acqua buona da bere, pulita e ricca di minerali essenziali per la salute di tutta la famiglia. Immagina di non avere più necessità di andare al supermercato per acquistare bottiglie e casse d'acqua, fare la fatica di trasportare il peso a casa e poi occupare spazio in dispensa. Installare un filtro sotto il lavello è la soluzione comoda e intelligente per risparmiare soldi, tempo e stress. E dare ogni giorno il tuo prezioso contributo per un mondo libero dall'inquinamento delle plastiche.

Elleci Pure Micro

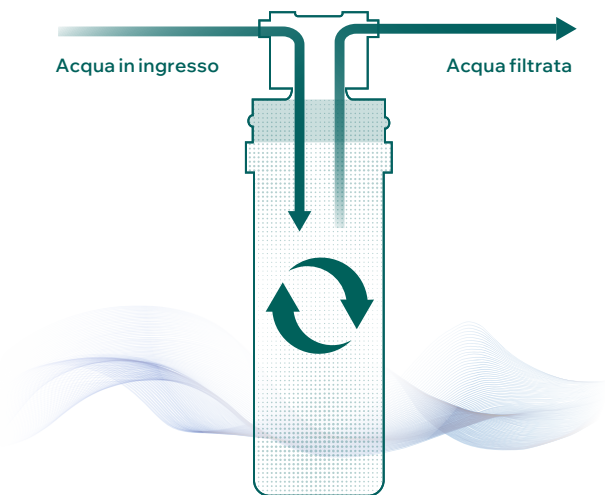

Il sistema di filtrazione Elleci Pure Micro
 combina azioni diverse per raggiungere prestazioni eccellenti



1. Microfiltrazione

Trattiene **ruggine, muffa, alghe e microparticelle** in sospensione fino a 0,5 micron



2. Carboni attivi

Rimuove **cloro, metalli e residui tossici**, utilizzando carboni attivi 100% sostenibili



3. Sali d'argento

Impedisce la riproduzione di **microrganismi**, assicurando una potente azione antibatterica



CARATTERISTICHE

Filtro multi-azione 0,5 micron con carboni attivi e sali d'argento

Autonomia

15.000 L/1 anno – ideale per consumo annuo di una famiglia

N.B. Il sistema di filtrazione è efficace esclusivamente con acqua potabile

ACCESSORI INCLUSI

Testata, deviatore, contaltri digitale

micron
0,5

AFICAMGR € 350

**pure
water**

Purifica l'acqua
da batteri, virus
e sostanze dannose

**pure
taste**

Migliora
notevolmente
gusto, odore
e durezza dell'acqua

**pure
planet**

Riduce il consumo
di plastica
e le emissioni di CO2

River new

Miscelatore monocomando con canna alta girevole a molla e doccetta orientabile doppio getto.

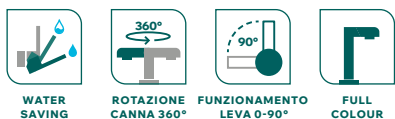

Chef new design

Miscelatore monocomando con canna alta girevole a molla e doccetta orientabile doppio getto.



CARATTERISTICHE

Base canna Ø 52 mm
 Rotazione canna 360°
 Funzionamento leva 0-90°
 Tipologia flessibile Inox 3/8" mm
 Lunghezza flessibile 600 mm
 Cartuccia Ø 35 mm
 Foro incasso Ø 35 mm

€ 350

● CR Cromo MIKRIVCR

€ 370

● GM Gun metal MOKRIVGM

● BK Black MOKRIVBK

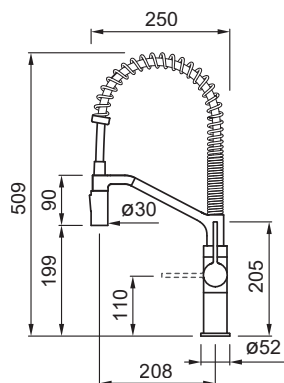

CARATTERISTICHE

Base canna Ø 50 mm
 Rotazione canna 360°
 Tipologia flessibile Inox 3/8" mm
 Lunghezza flessibile 400 mm
 Cartuccia Ø 35 mm
 Foro incasso Ø 35 mm

€ 350

● CR Cromo MIKCHECR

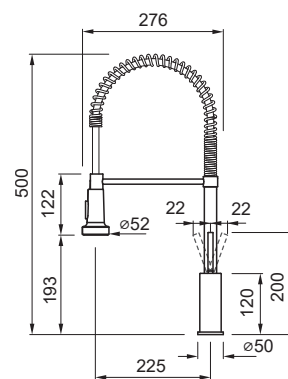

Nami new

Miscelatore monocomando con canna alta girevole in silicone e doccetta orientabile doppio getto.



WATER SAVING



ROTAZIONE CANNA 360°



FUNZIONAMENTO LEVA 0-90°

CARATTERISTICHE

Base canna Ø 50 mm
 Rotazione canna 360°
 Funzionamento leva 0-90°
 Tipologia flessibile Inox 3/8" mm
 Lunghezza flessibile 600 mm
 Cartuccia Ø 25 mm
 Foro incasso Ø 35 mm

€ 400

● GM Gun metal MOKNAMGM

€ 400

● BK Black MOKNAMBK

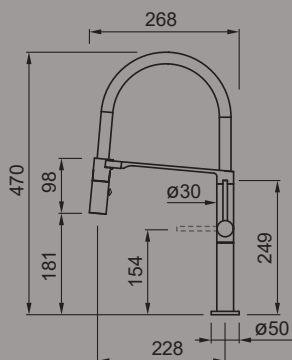

Wave

Miscelatore monocomando con canna alta girevole in silicone e doccetta orientabile.



ROTAZIONE CANNA 360°



FUNZIONAMENTO LEVA 0-90°

CARATTERISTICHE

Base canna Ø 50 mm
 Rotazione canna 360°
 Funzionamento leva 0-90°
 Tipologia flessibile Inox 3/8" mm
 Lunghezza flessibile 400 mm
 Cartuccia Ø 25 mm
 Foro incasso Ø 35 mm

€ 315

● CR Cromo MIKWAVCR

€ 360

● BK Black MOKWAVBK

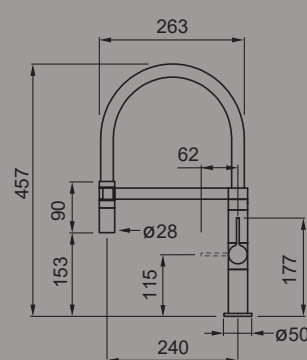
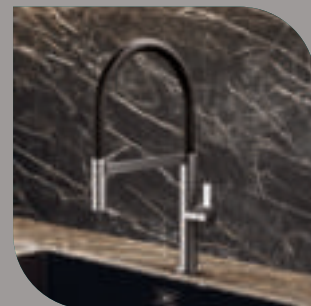

Kai new

Miscelatore monocomando con canna alta girevole e doccetta estraibile doppio getto.

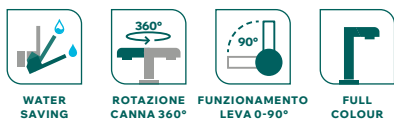

Stream PLUS

Miscelatore monocomando con canna alta girevole e doccetta estraibile.



CARATTERISTICHE

Base canna Ø 50 mm
 Rotazione canna 360°
 Funzionamento leva 0-90°
 Tipologia flessibile Inox 3/8" mm
 Lunghezza flessibile 600 mm
 Cartuccia Ø 25 mm
 Foro incasso Ø 35 mm

€ 320

● CR Cromo MIKKAICR

€ 360

● GM Gun metal MOKKAIGM

● BK Black MOKKAIBK

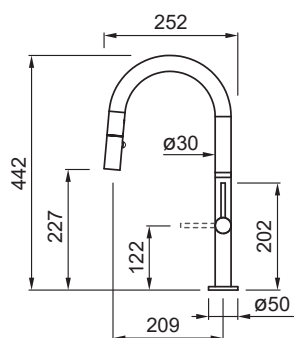

CARATTERISTICHE

Base canna Ø 54 mm
 Rotazione canna 360°
 Funzionamento leva 0-90°
 Tipologia flessibile Inox 3/8" mm
 Lunghezza flessibile 470 mm
 Cartuccia Ø 35 mm
 Foro incasso Ø 35 mm

€ 365

● CR Cromo MIKSTPCR

€ 415

● G40 Nero MGKSTP40

● G78 Espresso MGKSTP78

● G48 Cemento MGKSTP48

● G43 Tortora MGKSTP43

● M79 Nuvola MMKSTP79

● G39 Bianco Soft MGKSTP39

● G68 Bianco MGKSTP68

● G59 Antracite MGKSTP59

● G51 Avena MGKSTP51

● G62 Bianco Antico MGKSTP62

€ 415

● K86 Black MKKSTP86

● K99 Concrete MKKSTP99

● K95 Champagne MKKSTP95

○ K96 White MKKSTP96

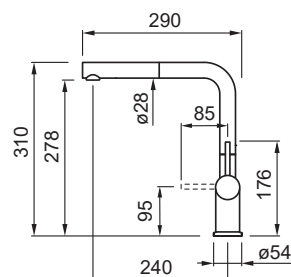

Loch new

Miscelatore monocomando con canna alta girevole e doccia estraibile.

CARATTERISTICHE

Base canna Ø 50 mm
 Rotazione canna 360°
 Funzionamento leva 0-90°
 Tipologia flessibile Inox 3/8" mm
 Lunghezza flessibile 600 mm
 Cartuccia Ø 25 mm
 Foro incasso Ø 35 mm

€ 370

 GM Gun metal MOKLOCGM

€ 370

 BK Black MOKLOCBK

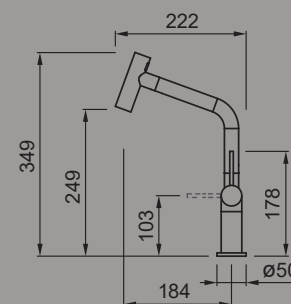

WATER SAVING



ROTAZIONE CANNA 360°



FUNZIONAMENTO LEVA 0-90°



FULL COLOUR

Trail

Miscelatore monocomando con canna alta girevole.



Trail PLUS

Miscelatore monocomando con canna alta girevole e doccetta estraibile.

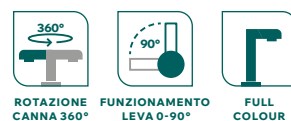

CARATTERISTICHE

Base canna Ø 54 mm
 Rotazione canna 360°
 Funzionamento leva 0-90°
 Tipologia flessibile Inox 3/8" mm
 Lunghezza flessibile 470 mm
 Cartuccia Ø 35 mm
 Foro incasso Ø 35 mm

€ 215

● CR Cromo	MIKTRACR
€ 250	
● G40 Nero	MGKTRA40
● G78 Espresso	MGKTRA78
● G48 Cemento	MGKTRA48
● G43 Tortora	MGKTRA43
● M79 Nuvola	MMKTRA79
● G39 Bianco Soft	MGKTRA39
● G68 Bianco	MGKTRA68
● G59 Antracite	MGKTRA59
● G51 Avena	MGKTRA51
● G62 Bianco Antico	MGKTRA62

● K86 Black	MKKTRA86
● K99 Concrete	MKKTRA99
● K95 Champagne	MKKTRA95
● K96 White	MKKTRA96

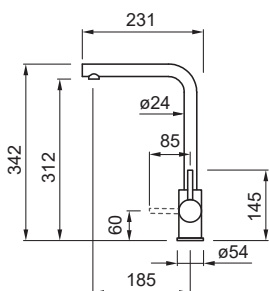

CARATTERISTICHE

Base canna Ø 54 mm
 Rotazione canna 360°
 Funzionamento leva 0-90°
 Tipologia flessibile Inox 3/8" mm
 Lunghezza flessibile 470 mm
 Cartuccia Ø 35 mm
 Foro incasso Ø 35 mm

€ 290

● CR Cromo	MIKTRPCR
€ 320	
● G40 Nero	MGKTRP40
● G78 Espresso	MGKTRP78
● G48 Cemento	MGKTRP48
● G43 Tortora	MGKTRP43
● M79 Nuvola	MMKTRP79
● G39 Bianco Soft	MGKTRP39
● G68 Bianco	MGKTRP68
● G59 Antracite	MGKTRP59
● G51 Avena	MGKTRP51
● G62 Bianco Antico	MGKTRP62

● K86 Black	MKKTRP86
● K99 Concrete	MKKTRP99
● K95 Champagne	MKKTRP95
● K96 White	MKKTRP96

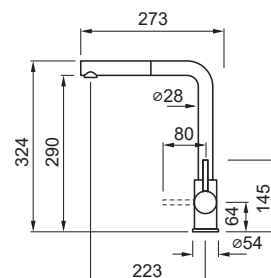

Senna

Miscelatore monocomando con canna alta girevole.



CARATTERISTICHE

Base canna	Ø 54 mm
Rotazione canna	360°
Funzionamento leva	0-90°
Tipologia flessibile	Inox 3/8" mm
Lunghezza flessibile	400 mm
Cartuccia	Ø 40 mm
Foro incasso	Ø 35 mm

€ 175

● CR Cromo MIKSENCR

€ 220

● G40 Nero MGKSEN40

● G68 Bianco MGKSEN68

● G59 Antracite MGKSEN59

● G51 Avena MGKSEN51

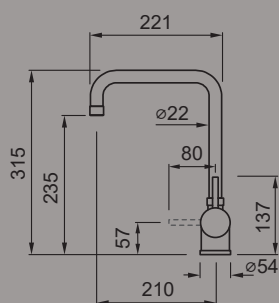

Danubio

new design

Miscelatore reclinabile monocomando con canna alta girevole.



CARATTERISTICHE

Base canna	Ø 50 mm
Rotazione canna	360°
Funzionamento leva	0-90°
Tipologia flessibile	Inox 3/8" mm
Lunghezza flessibile	400 mm
Cartuccia	Ø 35 mm
Foro incasso	Ø 35 mm

€ 370

● CR Cromo MIKDANCR

€ 410

● G40 Nero MGKDAN40

● G68 Bianco MGKDAN68

● G51 Avena MGKDAN51

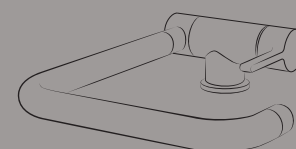

Reclinabile

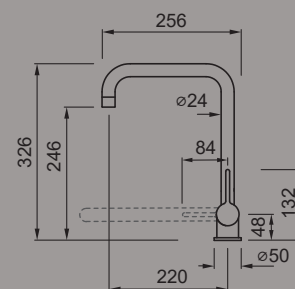

Neva

Miscelatore monocomando con canna alta girevole e doccetta estraibile.

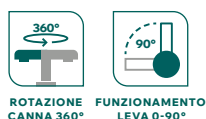

ROTAZIONE
CANNA 360°
FUNZIONAMENTO
LEVA 0-90°

CARATTERISTICHE

Base canna Ø 50 mm
Rotazione canna 360°
Funzionamento leva 0-90°
Tipologia flessibile Inox 3/8" mm
Lunghezza flessibile 400 mm
Cartuccia Ø 35 mm
Foro incasso Ø 35 mm

€ 280

● IN Inox spazzolato MIKNEVIN

€ 280

- G40 Nero MGKNEV40
- G68 Bianco MGKNEV68
- G59 Antracite MGKNEV59
- G51 Avena MGKNEV51
- G62 Bianco Antico MGKNEV62

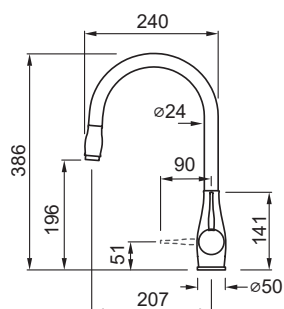

INOX
AISI304

Realizzato completamente in Acciaio Inox AISI304

Adige

Miscelatore monocomando con canna alta girevole.



ROTAZIONE
CANNA 360°
FUNZIONAMENTO
LEVA 0-90°
FULL
COLOUR

CARATTERISTICHE

Base canna Ø 50 mm
Rotazione canna 360°
Funzionamento leva 0-90°
Tipologia flessibile Inox 3/8" mm
Lunghezza flessibile 400 mm
Cartuccia Ø 35 mm
Foro incasso Ø 35 mm

€ 280

● IN Inox spazzolato MIKADIIN

€ 280

- G40 Nero MGKADI40
- G68 Bianco MGKADI68
- K86 Black MKKADI86
- K96 White MKKADI96

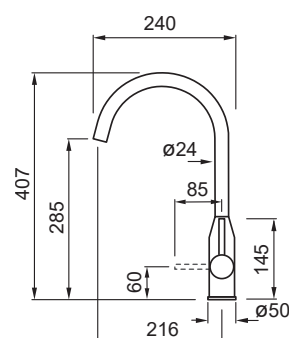

INOX
AISI304

Realizzato completamente in Acciaio Inox AISI304

Dora PLUS

Miscelatore monocomando con canna alta girevole e doccetta estraibile.

CARATTERISTICHE

Base canna Ø 50 mm
 Rotazione canna 360°
 Funzionamento leva 0-90°
 Tipologia flessibile Inox 3/8" mm
 Lunghezza flessibile 400 mm
 Cartuccia Ø 35 mm
 Foro incasso Ø 35 mm

● G40 Nero
 ● G68 Bianco
 ● K86 Black
 ● K96 White

€ 360

MGKDRP40
 MGKDRP68
 MKKDRP86
 MKKDRP96

€ 360

● IN Inox Spazzolato MIKDRPIN

INOX

AISI304 Realizzato completamente in Acciaio Inox AISI304

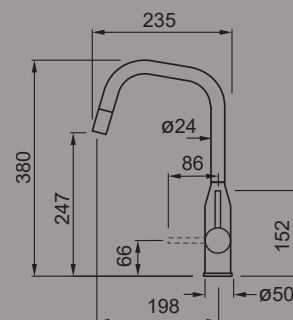

ROTAZIONE
CANNA 360°



FUNZIONAMENTO
LEVA 0-90°



FULL
COLOUR

Athena

Miscelatore monocomando con canna alta girevole.



Athena PLUS

Miscelatore monocomando con canna alta girevole e doccetta estraibile.



CARATTERISTICHE

Base canna Ø 48 mm
 Rotazione canna 360°
 Funzionamento leva 0-90°
 Tipologia flessibile Inox 3/8" mm
 Lunghezza flessibile 500 mm
 Cartuccia Ø 25 mm
 Foro incasso Ø 35 mm

€ 280

● CR Cromo MIKATHCR

€ 320

● G40 Nero MGKATH40

● G48 Cemento MGKATH48

● G43 Tortora MGKATH43

● M79 Nuvola MMKATH79

● G68 Bianco MGKATH68

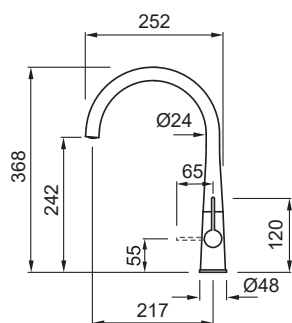

CARATTERISTICHE

Base canna Ø 48 mm
 Rotazione canna 360°
 Funzionamento leva 0-90°
 Tipologia flessibile Inox 3/8" mm
 Lunghezza flessibile 500 mm
 Cartuccia Ø 25 mm
 Foro incasso Ø 35 mm

€ 300

● CR Cromo MIKATPCR

€ 340

● G40 Nero MGKATP40

● G48 Cemento MGKATP48

● G43 Tortora MGKATP43

● M79 Nuvola MMKATP79

● G68 Bianco MGKATP68

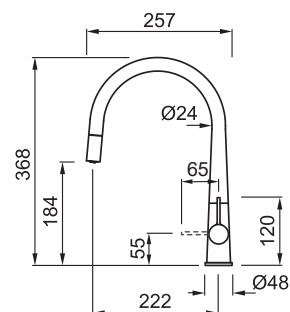

Bridge new design

Miscelatore monocomando con canna alta girevole.



CARATTERISTICHE

Base canna	Ø 46 mm
Rotazione canna	360°
Funzionamento leva	0-90°
Tipologia flessibile	Inox 3/8" mm
Lunghezza flessibile	400 mm
Cartuccia	Ø 25 mm
Foro incasso	Ø 35 mm

€ 235

● CR Cromo MIKBRICR

€ 280

- G40 Nero MGKBRI40
- G48 Cemento MGKBRI48
- G43 Tortora MGKBRI43
- G68 Bianco MGKBRI68
- K96 White MKKBRI96
- K86 Black MKKBRI86

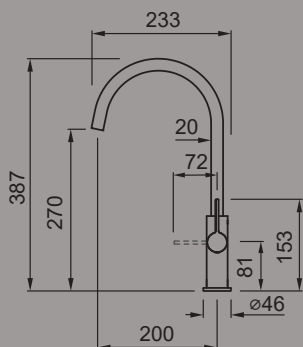

Cloud

Miscelatore monocomando con canna alta girevole.



CARATTERISTICHE

Base canna	Ø 54 mm
Rotazione canna	360°
Funzionamento leva	0-90°
Tipologia flessibile	Inox 3/8" mm
Lunghezza flessibile	470 mm
Cartuccia	Ø 35 mm
Foro incasso	Ø 35 mm

€ 200

● CR Cromo MIKCLOCR

€ 255

- G40 Nero MGKLO40
- G78 Espresso MGKLO78
- G48 Cemento MGKLO48
- G43 Tortora MGKLO43
- 79 Nuvola MMKLO79
- G39 Bianco Soft MGKLO39
- G68 Bianco MGKLO68
- G59 Antracite MGKLO59
- G51 Avena MGKLO51
- G62 Bianco Antico MGKLO62

€ 255

- K86 Black MKKLO86
- K99 Concrete MKKLO99
- K95 Champagne MKKLO95
- K96 White MKKLO96

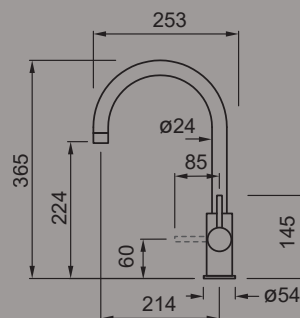

Reno

Miscelatore monocomando con canna girevole e doccetta estraibile.



Sava

Miscelatore monocomando con canna girevole.



CARATTERISTICHE

Base canna	Ø 50 mm
Rotazione canna	115°
Tipologia flessibile	Inox 3/8" mm
Lunghezza flessibile	400 mm
Cartuccia	Ø 35 mm
Foro incasso	Ø 35 mm

€ 275

● CR Cromo MIKRENCR

€ 330

- G40 Nero MGKREN40
- G48 Cemento MGKREN48
- G43 Tortora MGKREN43
- G68 Bianco MGKREN68
- G59 Antracite MGKREN59
- K86 Black MKKREN86
- K96 White MKKREN96

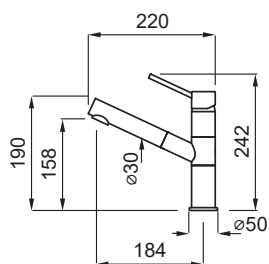

CARATTERISTICHE

Base canna	Ø 50 mm
Rotazione canna	360°
Tipologia flessibile	Inox 3/8" mm
Lunghezza flessibile	400 mm
Cartuccia	Ø 35 mm
Foro incasso	Ø 35 mm

€ 220

● CR Cromo MIKSAVCR

€ 270

- G40 Nero MGKSAV40
- G48 Cemento MGKSAV48
- G43 Tortora MGKSAV43
- G68 Bianco MGKSAV68
- G59 Antracite MGKSAV59
- K86 Black MKKSAV86
- K96 White MKKSAV96

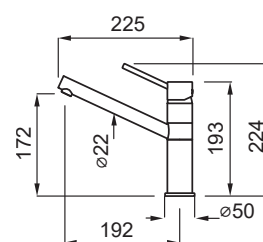

Taos new

Miscelatore monocomando con canna girevole e doccetta estraibile doppio getto.

CARATTERISTICHE

Base canna Ø 46 mm
 Rotazione canna 90°
 Tipologia flessibile Inox 3/8" mm
 Lunghezza flessibile 600 mm
 Cartuccia Ø 35 mm
 Foro incasso Ø 35 mm

€ 285

● CR Cromo MIKTAOCR

€ 340

● BK Black MOKTAOBK

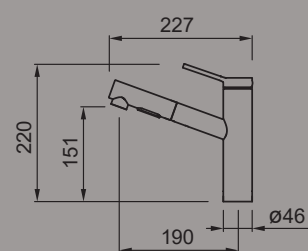

WATER
SAVING



FULL
COLOUR

Venere

Miscelatore monocomando con canna girevole e doccetta estraibile doppio getto.

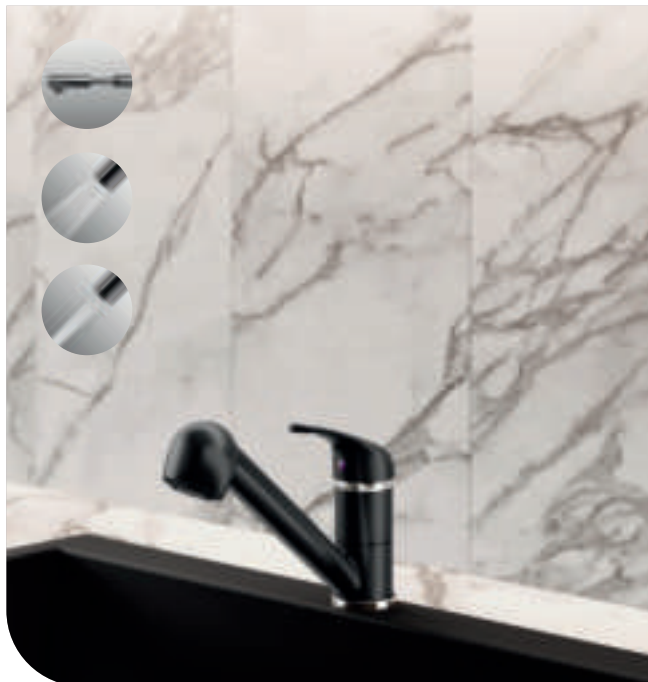

Minerva

Miscelatore monocomando con canna girevole.



CARATTERISTICHE

Base canna	Ø 55 mm
Rotazione canna	125°
Tipologia flessibile	Inox 3/8" mm
Lunghezza flessibile	400 mm
Cartuccia	Ø 40 mm
Foro incasso	Ø 35 mm

€ 150

● CR Cromo MIKVENCR

€ 190

● G40 Nero MGKVEN40

○ G68 Bianco MGKVEN68

● G59 Antracite MGKVEN59

● G51 Avena MGKVEN51

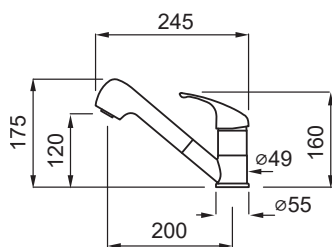

CARATTERISTICHE

Base canna	Ø 55 mm
Rotazione canna	360°
Tipologia flessibile	Inox 3/8" mm
Lunghezza flessibile	400 mm
Cartuccia	Ø 40 mm
Foro incasso	Ø 35 mm

€ 110

● CR Cromo MIKMINCR

€ 150

● G40 Nero MGKMIN40

○ G68 Bianco MGKMIN68

● G59 Antracite MGKMIN59

● G51 Avena MGKMIN51

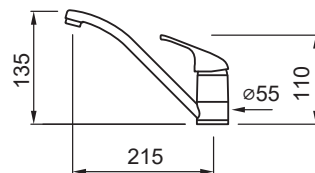

Po

Miscelatore monocomando con canna girevole.



ROTAZIONE
CANNA 360°



FUNZIONAMENTO
LEVA 0-90°

CARATTERISTICHE

Base canna	Ø 51 mm
Rotazione canna	360°
Funzionamento leva	0-90°
Tipologia flessibile	Nylon 3/8" mm
Lunghezza flessibile	370 mm
Cartuccia	Ø 35 mm
Foro incasso	Ø 35 mm

€ 200

● CR Cromo MIKPOCR

€ 220

● G40 Nero MGKPO40

● G68 Bianco MGKPO68

● G59 Antracite MGKPO59

● G51 Avena MGKPO51

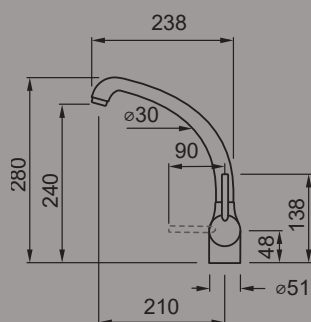

Rio

Miscelatore monocomando con canna girevole.



ROTAZIONE
CANNA 360°



FUNZIONAMENTO
LEVA 0-90°

CARATTERISTICHE

Base canna	Ø 54 mm
Rotazione canna	360°
Funzionamento leva	0-90°
Tipologia flessibile	Inox 3/8" mm
Lunghezza flessibile	370 mm
Cartuccia	Ø 40 mm
Foro incasso	Ø 35 mm

€ 315

● CR Cromo MIKRIOCR

€ 350

● OT Ottone MIKRIOOT

€ 335

● G51 Avena MGKRIO51

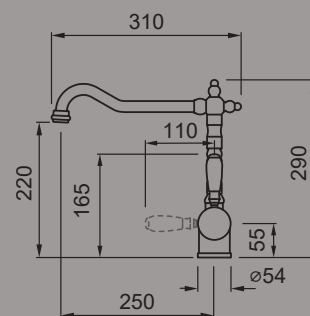

Elettrodomestici

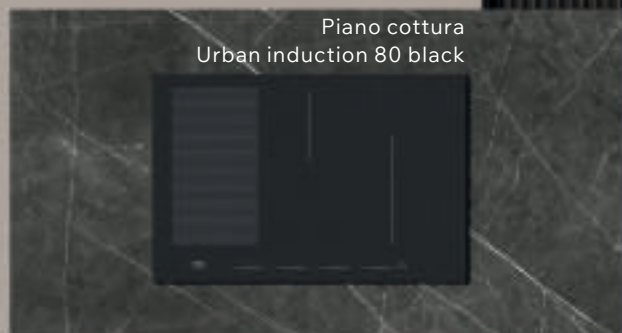

Piano cottura
Urban induction 80 black



Piano cottura
Urban induction 80 city dune



Microonde Urban
total black

Forno Urban plus
total black

Forno Urban
total black



Forno Plano plus e microonde G43 tortora



Piano cottura Urban glass 75
total black

Piano cottura
Plano 75 G43 tortora

Time workstation undermount 130
G43 tortora



Microonde Plano
G40 nero



Forno Plano
G40 nero



Piano cottura Plano 90
G40 nero

Spazio workstation 600
K86 black



Forno Country
G59 antracite



Piano cottura Style country 90
G59 antracite



Urban 80 INDUCTION

Piano cottura induzione in vetroceramica 80 cm

CARATTERISTICHE

MATERIALE = Vetroceramica

Comandi slider con led bianchi

4 zone cottura con riconoscimento automatico delle pentole, potenza totale 7,4 kW

- 2 zone Bridge 210 x 190 mm potenza 2,1 kW (p=3 kw) posizione sx anteriore e posteriore

- 1 zona Φ = 250 mm potenza 2,3 kW (p=3 kW) posizione centrale

- 1 zona Φ = 160 mm potenza 1,4 kW (p=2,1 kW) posizione anteriore dx

Alimentazione monofase 220-240 V 50-60 Hz trifase 380-415 V 50-60 Hz

Regolazione elettronica su 9 livelli funzione powerboost per ogni zona cottura

Comando STOP & GO sospensione e riavvio cottura

Limitatore di potenza programmabile su 8 livelli con valore minimo 1,6 kW

Programmatore digitale del tempo di cottura indipendente per ciascuna zona

Funzione timer con allarme acustico

Funzione CHEF con preimpostazione 3 zone su livelli di cottura a potenza differenti

Funzione KEEP WARM mantenimento in caldo

Spegnimento automatico di sicurezza

Indicatore calore residuo

Blocco di sicurezza bambini

€ 1900

● BK Black

PVIU801BK

○ CD City Dune

PVIU801CD

new
colour

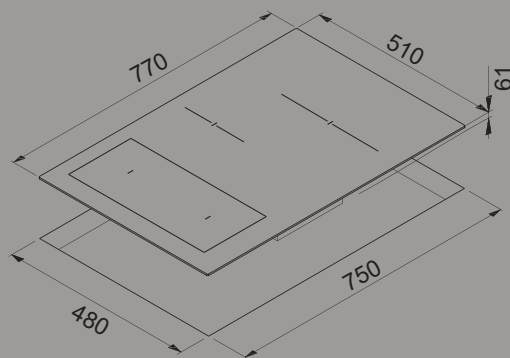

DISPLAY LED
BIANCHI



COMANDI
SLIDER



FUNZIONE
BRIDGE



SOSPENSIONE E
RIAVVIO COTTURA



COTTURA
CHEF



MANTENIMENTO
IN CALDO



Urban 60 INDUCTION

Piano cottura induzione in vitroceramica 60 cm



CARATTERISTICHE

MATERIALE = Vetroceramica

Comandi slider con led bianchi
 4 zone cottura con riconoscimento automatico delle pentole, potenza totale 7,4 kW
 - 2 zone Bridge 210 x 190 mm potenza 2,1 kW (P=3 kw) posizione sx anteriore e posteriore
 - 1 zona Φ = 200 mm Potenza 2,3 kW (P=3 kW) posizione posteriore dx
 - 1 zona Φ = 145 mm Potenza 1,4 kW (P=1,85 kW) posizione anteriore dx
 Alimentazione monofase 220-240 V 50-60 Hz trifase 380-415 V 50-60 Hz
 Regolazione elettronica su 9 livelli funzione powerboost per ogni zona cottura
 Comando STOP & GO sospensione e riavvio cottura
 Limitatore di potenza programmabile su 8 livelli con valore minimo 1,6 kW
 Programmatore digitale del tempo di cottura indipendente per ciascuna zona
 Funzione timer con allarme acustico
 Funzione CHEF con preimpostazione 3 zone su livelli di cottura a potenza differenti
 Funzione KEEP WARM mantenimento in caldo
 Spegnimento automatico di sicurezza
 Indicatore calore residuo
 Blocco di sicurezza bambini

€ 1800

- BK Black PVIU601BK
- CD City Dune PVIU601CD

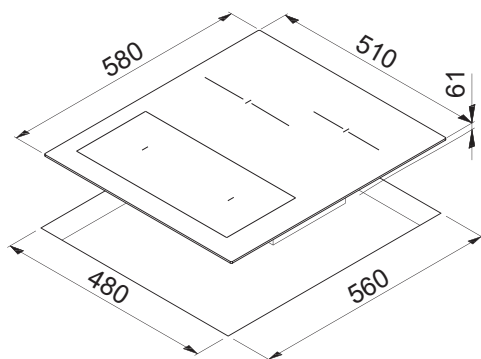

Urban 30 INDUCTION

Piano cottura induzione in vitroceramica 30 cm

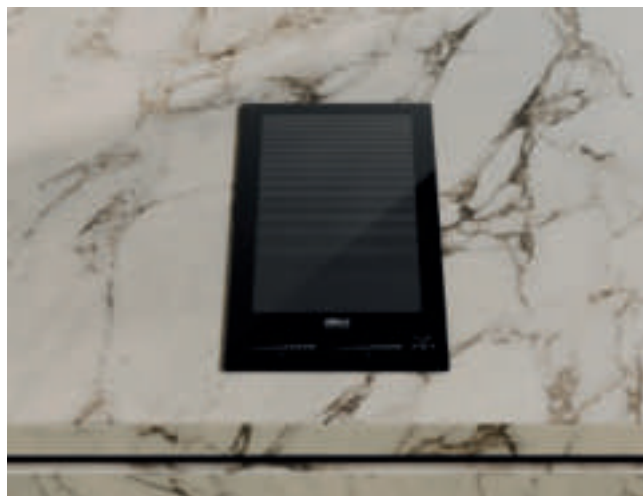

CARATTERISTICHE

MATERIALE = Vetroceramica

Comandi slider con led bianchi
 2 zone cottura con riconoscimento automatico delle pentole, potenza totale 3,7 kW
 - 2 zone Bridge 210 x 190 mm Potenza 2,1 kW (P=3 kW) anteriore e posteriore
 Alimentazione monofase 220-240 V 50-60 Hz trifase 380-415 V 50-60 Hz
 Regolazione elettronica su 9 livelli funzione powerboost per ogni zona cottura
 Comando STOP & GO sospensione e riavvio cottura
 Limitatore di potenza programmabile su 4 livelli con valore minimo 1,6 kW
 Programmatore digitale del tempo di cottura indipendente per ciascuna zona
 Funzione timer con allarme acustico
 Funzione KEEP WARM mantenimento in caldo
 Spegnimento automatico di sicurezza
 Indicatore calore residuo
 Blocco di sicurezza bambini

€ 1200

- BK Black PVIU301BK

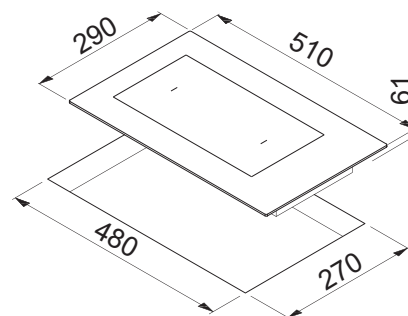

Urban 75 GLASS

new

Piano cottura gas in vetro temprato 75 cm

CARATTERISTICHE

MATERIALE = Vetro temprato nero

5 bruciatori a gas

- 1 semirapido potenza 1,75 kW posizione anteriore dx
- 1 semirapido potenza 1,75 kW posizione posteriore dx
- 1 rapido potenza 3 kW posizione posteriore sx
- 1 ausiliario potenza 1 kW posizione anteriore sx
- 1 bruciatore wok 4 kW posizione centrale

Griglie di appoggio singole in ghisa, copri spartifiamma in ghisa

Riduzione moka in dotazione

Manopole nere soft touch per una migliore piacevolezza di uso

Accensione elettrica sottomanopola

Predisposto per utilizzo con gas metano

Kit ugelli GPL in dotazione

Termovalvola di sicurezza

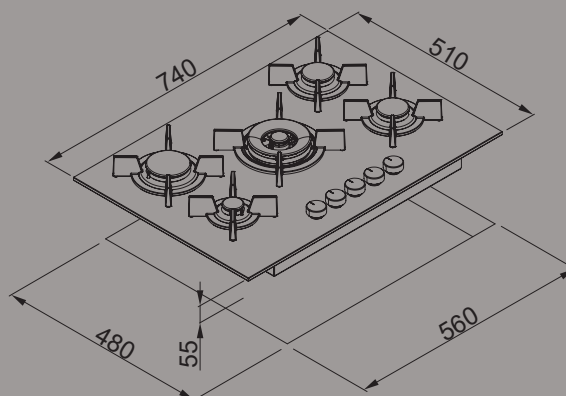

€ 900

● BK Black

PVGU752BK



CORONA
WOK



ACCENSIONE
INTEGRATA



GRIGLIE
IN GHISA



MANOPOLE
SOFT TOUCH



Urban 60 GLASS new

Piano cottura gas in vetro temprato 60 cm



CORONA
WOK



ACCENSIONE
INTEGRATA



GRIGLIE
IN GHISA



MANOPOLE
SOFT TOUCH

CARATTERISTICHE

MATERIALE = Vetro temprato nero

4 bruciatori a gas

- 1 ausiliario potenza 1 kW posizione anteriore dx
- 1 semirapido potenza 1,75 kW posizione posteriore dx
- 1 semirapido potenza 1,75 kW posizione posteriore sx
- 1 bruciatore wok 4 kW posizione anteriore sx

Griglie di appoggio singole in ghisa, copri spartifiamma in ghisa

Riduzione moka in dotazione

Manopole nere soft touch per una migliore piacevolezza di uso

Accensione elettrica sottomanopola

Predisposto per utilizzo con gas metano

Kit ugelli GPL in dotazione

Termovalvola di sicurezza

€ 750



BK Black

PVGU602BK

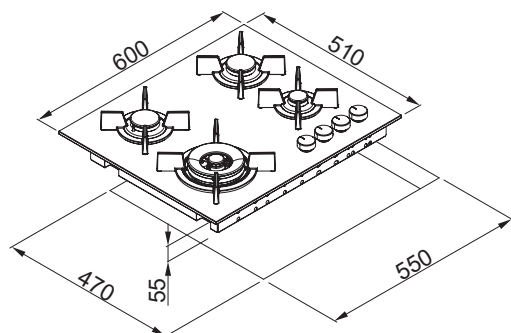

Plano 90

Piano cottura gas in metallo smaltato 90 cm

CARATTERISTICHE

MATERIALE = Metallo smaltato

5 bruciatori a gas

- 1 semirapido potenza 1,75 kW posizione anteriore sx
- 1 ausiliario potenza 1 kW posizione posteriore sx
- 1 semirapido potenza 1,75 kW posizione posteriore dx
- 1 rapido potenza 3 kW posizione anteriore sx
- 1 bruciatore wok 4 kW posizione centrale

Griglie di appoggio singole in ghisa, copri spartifiamma in ghisa

Manopole nere soft touch per una migliore piacevolezza di uso

Accensione elettrica sottomanopola

Predisposto per utilizzo con gas metano

Kit ugelli GPL in dotazione

Termovalvola di sicurezza

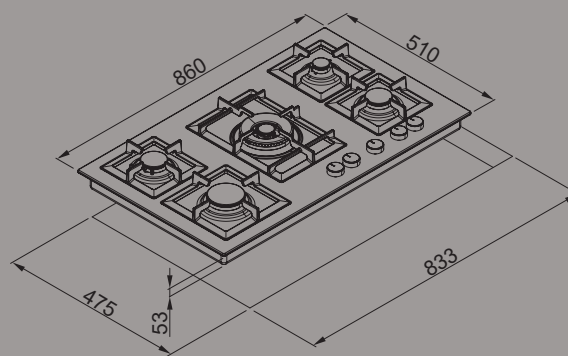

CORONA
WOK



ACCENSIONE
INTEGRATA



GRIGLIE
IN GHISA



MANOPOLE
SOFT TOUCH



Plano 90

€ 750



G68 Bianco

PGSP90168CS

Abbinabile a K96 White



G40 Nero

PGSP90140CS

Abbinabile a K86 Black

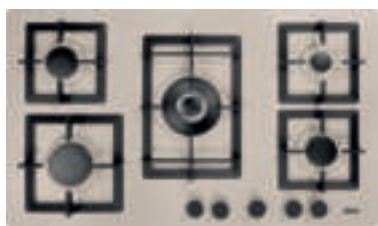

G51 Avena

PGSP90151CS



Plano 75

Piano cottura gas in metallo smaltato 75 cm



M79 Nuvola PMS75179CS Abbinabile al K88 Cloud



CORONA WOK



ACCENSIONE INTEGRATA



GRIGLIE INGHISA



MANOPOLE SOFT TOUCH

CARATTERISTICHE

MATERIALE = Metallo smaltato

5 bruciatori a gas

- 1 semirapido potenza 1,75 kW posizione anteriore dx
- 1 semirapido potenza 1,75 kW posizione posteriore dx
- 1 rapido potenza 3 kW posizione posteriore sx
- 1 ausiliario potenza 1 kW posizione anteriore sx
- 1 bruciatore wok 4 kW posizione centrale

Griglie di appoggio singole in ghisa, copri spartifiamma in ghisa

Manopole nere soft touch per una migliore piacevolezza di uso

Accensione elettrica sottomanopola

Predisposto per utilizzo con gas metano

Kit ugelli GPL in dotazione

Termovalvola di sicurezza

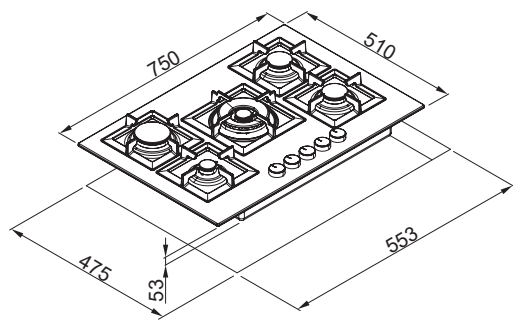

€ 680



G40 Nero PGSP75140CS
Abbinabile a K86 Black



G48 Cemento PGSP75148CS
Abbinabile a K99 Concrete

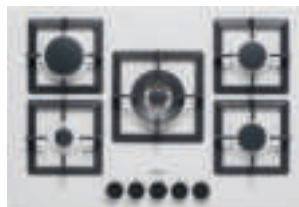

G68 Bianco PGSP75168CS
Abbinabile a K96 White

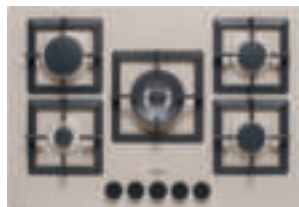

G51 Avena PGSP75151CS

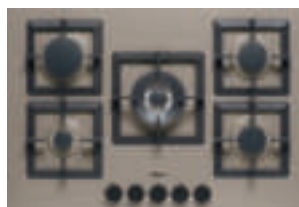

G43 Tortora PGSP75143CS
Abbinabile a K89 Dove

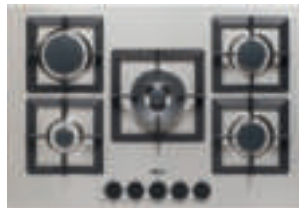

IN Inox PIAP7511NCS

Plano 60

Piano cottura gas in metallo smaltato 60 cm



● G43 Tortora PGSP60143WS Abbinabile al K99 Dove



CARATTERISTICHE

MATERIALE = Metallo smaltato

- 4 bruciatori a gas
- 1 ausiliario potenza 1 kW posizione anteriore dx
- 1 semirapido potenza 1,75 kW posizione posteriore dx
- 1 semirapido potenza 1,75 kW posizione posteriore sx
- 1 bruciatore Wok 4 kW posizione anteriore sx
- Griglie di appoggio singole in ghisa, copri spartifiamma in ghisa
- Manopole nere soft touch per una migliore piacevolezza di uso
- Accensione elettrica sottomanopola
- Predisposto per utilizzo con gas metano
- Kit ugelli GPL in dotazione
- Termovalvola di sicurezza

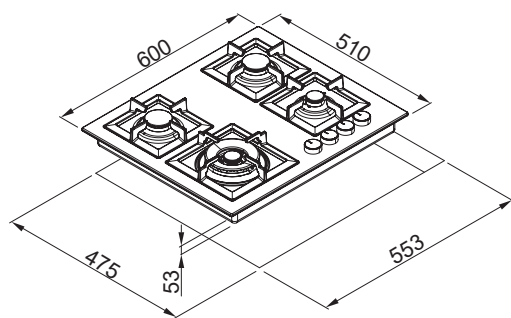

€ 610



● G40 Nero PGSP60140WS
Abbinabile a K86 Black

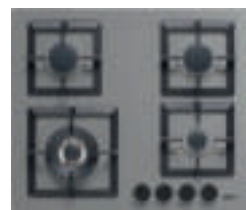

● G48 Cemento PGSP60148WS
Abbinabile a K99 Concrete

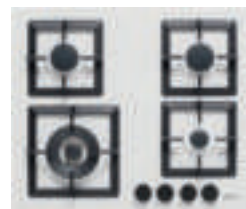

○ G68 Bianco PGSP60168WS
Abbinabile a K96 White

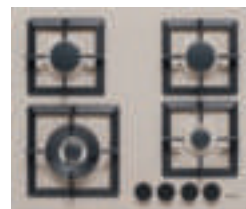

● G51 Avena PGSP60151WS

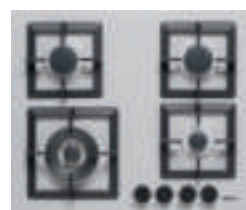

● M79 Nuvola PMSP60179WS
Abbinabile a K88 Cloud



● IN Inox PIAP6011NWS

Style country 90

Piano cottura gas in metallo smaltato 90 cm

CARATTERISTICHE

MATERIALE = Metallo smaltato

5 bruciatori a gas

- 1 semirapido potenza 1,75 kW posizione anteriore dx
- 1 rapido potenza 3 kW posizione posteriore dx
- 1 semirapido potenza 1,75 kW posizione posteriore sx
- 1 ausiliario potenza 1 kW posizione anteriore sx
- 1 bruciatore wok 4 kW posizione centrale

Griglie di appoggio singole in ghisa, copri spartifiamma in ghisa

Manopole finitura ottonata

Accensione elettrica sottomanopola

Predisposto per utilizzo con gas metano

Kit ugelli GPL in dotazione

Termovalvola di sicurezza

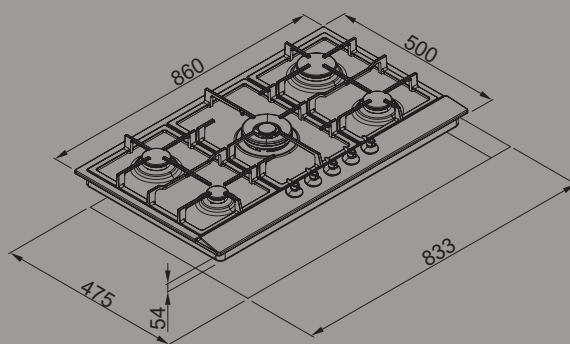

CORONA
WOK



ACCENSIONE
INTEGRATA



GRIGLIE
IN GHISA



Style country 90

€ 750



G51 Avena

PGSC90151CN



G59 Antracite

PGSC90159CN



Style country 75

Piano cottura gas in metallo smaltato 75 cm



CORONA
WOK



ACCENSIONE
INTEGRATA



GRIGLIE
IN GHISA

€ 700



G51 Avena

PGSC75351CB



G59 Antracite

PGSC75359CB

CARATTERISTICHE

MATERIALE = Metallo smaltato

5 bruciatori a gas

- 1 semirapido potenza 1,75 kW posizione anteriore dx
- 1 rapido potenza 3 kW posizione posteriore dx
- 1 semirapido potenza 1,75 kW posizione posteriore sx
- 1 ausiliario potenza 1 kW posizione anteriore sx
- 1 bruciatore wok 4 kW posizione centrale

Griglie di appoggio singole in ghisa, copri spartifiamma in ghisa

Manopole finitura ottonata

Accensione elettrica sottomanopola

Predisposto per utilizzo con gas metano

Kit ugelli GPL in dotazione

Termovalvola di sicurezza

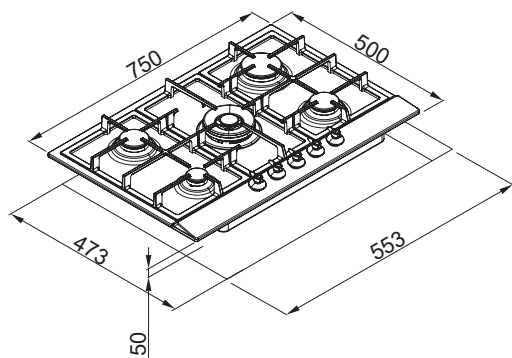

Style country 60

Piano cottura gas in metallo smaltato 60 cm



€ 650



G51 Avena PGSC60251WB

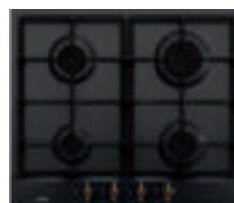

G59 Antracite PGSC60259WB

CARATTERISTICHE

MATERIALE = Metallo smaltato

4 bruciatori a gas

- 1 semirapido potenza 1,75 kW posizione anteriore dx

- 1 rapido potenza 3 kW posizione posteriore dx

- 1 semirapido potenza 1,75 kW posizione posteriore sx

- 1 ausiliario potenza 1 kW posizione anteriore sx

Griglie di appoggio singole in ghisa, copri spartifiamma in ghisa

Manopole finitura ottonata

Accensione elettrica sottomanopola

Predisposto per utilizzo con gas metano

Kit ugelli GPL in dotazione

Termovalvola di sicurezza

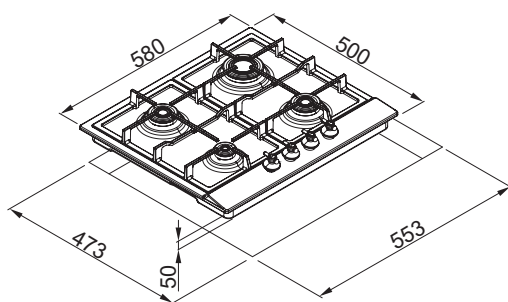

Style 75

Piano cottura gas in metallo smaltato 75 cm



CORONA
WOK



ACCENSIONE
INTEGRATA



MANOPOLE
SOFT TOUCH

CARATTERISTICHE

MATERIALE = Metallo smaltato

5 bruciatori a gas

- 1 semirapido potenza 1,75 kW posizione anteriore dx
- 1 rapido potenza 3 kW posizione posteriore dx
- 1 semirapido potenza 1,75 kW posizione posteriore sx
- 1 ausiliario potenza 1 kW posizione anteriore sx
- 1 bruciatore wok 4 kW posizione centrale

Griglie di appoggio lamellari

Manopole nere soft touch per una migliore piacevolezza di uso

Accensione elettrica sottomanopola

Predisposto per utilizzo con gas metano

Kit ugelli GPL in dotazione

Termovalvola di sicurezza

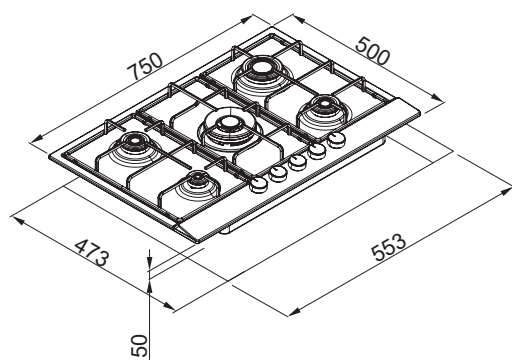

€ 630

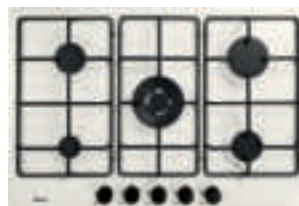

G68 Bianco PGSS75368CB
Abbinabile al K96 White



G48 Cemento PGSS75348CB
Abbinabile al K99 Concrete



G51 Avena PGSS75351CB



G59 Antracite PGSS75359CB

Style 60

Piano cottura gas in metallo smaltato 60 cm



ACCENSIONE INTEGRATA

MANOPOLE SOFT TOUCH

CARATTERISTICHE

MATERIALE = Metallo smaltato

4 bruciatori a gas

- 1 ausiliario potenza 1 kW posizione anteriore dx
- 1 rapido potenza 3 kW posizione posteriore dx
- 1 semirapido potenza 1,75 kW posizione posteriore sx
- 1 ausiliario potenza 1 kW posizione anteriore sx

Griglie di appoggio lamellari

Manopole nere soft touch per una migliore piacevolezza di uso

Accensione elettrica sottomanopola

Predisposto per utilizzo con gas metano

Kit ugelli GPL in dotazione

Termovalvola di sicurezza

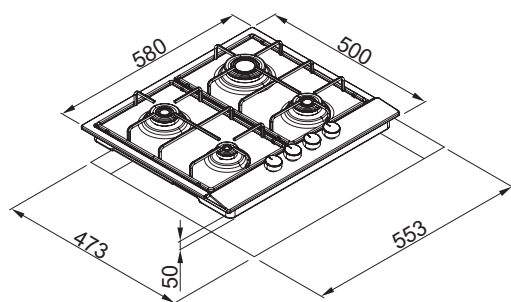

€ 500



G68 Bianco PGSS60268WB
Abbinabile al K96 White



G48 Cemento PGSS60248WB
Abbinabile al K99 Concrete



G51 Avena PGSS60251WB



G59 Antracite PGSS60259WB

Urban Plus

Forno termoventilato total glass 60 cm, 8 funzioni

CARATTERISTICHE

MATERIALE = Vetro

FUNZIONI FORNO

Ventilazione, resistenza superiore e inferiore, resistenza superiore e inferiore con ventilazione, resistenza circolare con ventilazione, easy clean, grill con ventilazione, grill, cottura multifunzionale (3D)

Display digitale con timer Led bianchi
 Easy Clean pulizia a vapore
 Regolazione della temperatura 40- 240 °C
 Cavit  XXL: volume 80 Litri
 6 livelli di cottura con guide laterali cromate
 Manopole nere soft touch e maniglia nera
 Illuminazione interna alogena
 Porta fredda con triplo vetro
 Vetri e porta removibili
 Classe energetica A

ACCESSORI INCLUSI = 1 griglia, 1 leccarda smaltata
ACCESSORI OPZIONALI = 1 griglia air fry AGF001IN € 70

€ 850

● BK Black

FVUP601BKNB

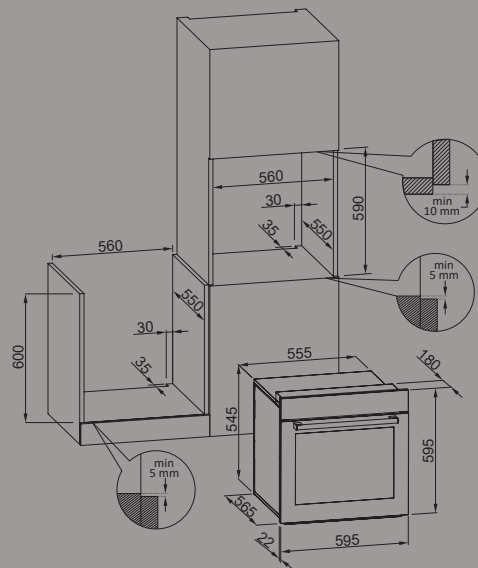

DISPLAY LED
BIANCHI



PULIZIA A
VAPORE



PORTA
FREDDA



VETRO PORTA
RIMOVIBILE



MANOPOLE
SOFT TOUCH



CAVITÀ
XXL



Urban

Forno termoventilato total glass 60 cm , 7 funzioni



CARATTERISTICHE

MATERIALE = Vetro

FUNZIONI FORNO

Illuminazione con ventilazione, grill con ventilazione, resistenza inferiore con ventilazione, resistenza superiore e inferiore, resistenza superiore e inferiore con ventilazione, resistenza superiore con ventilazione, grill

Timer meccanico

Regolazione della temperatura 40- 240 °C

Cavità XXL: volume 80 Litri

6 livelli di cottura con guide laterali cromate

Manopole nere soft touch e maniglia nera

Illuminazione interna alogena

Porta fredda con triplo vetro

Vetri e porta removibili

Classe energetica A

ACCESSORI INCLUSI = 1 griglia, 1 leccarda smaltata

ACCESSORI OPZIONALI = 1 griglia air fry AGF001IN € 70

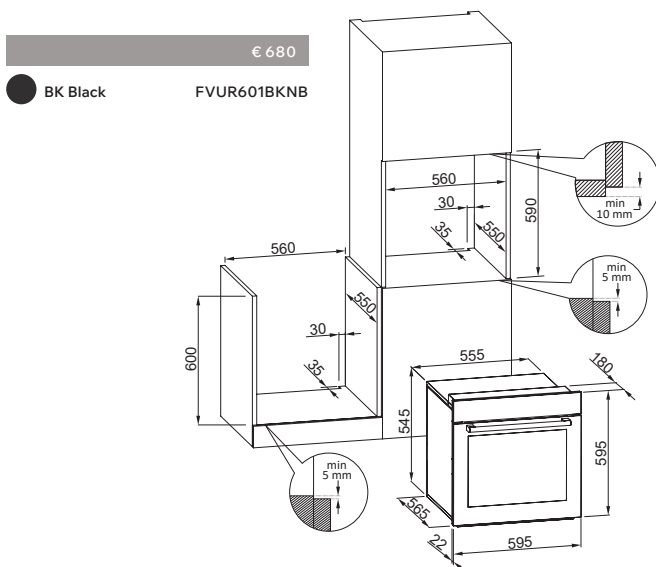

Urban MW

Forno microonde total glass 38 cm, 10 programmi



CARATTERISTICHE

MATERIALE = Vetro

FUNZIONI MICROONDE

10 programmi per diverse tipologie di cibo

Microonde

Microonde + grill

Scongelamento con inserimento tempo

Scongelamento con inserimento peso

Timer

Display digitale con timer Led bianchi

Regolazione della temperatura

Volume Cavità: 28 Litri

Cavità in acciaio inox

Comandi touch control

Apertura porta: Sinistra

Sicurezza: funzione blocco bambini

ACCESSORI INCLUSI = 1 piatto girevole in vetro da 288 mm, 1 griglia

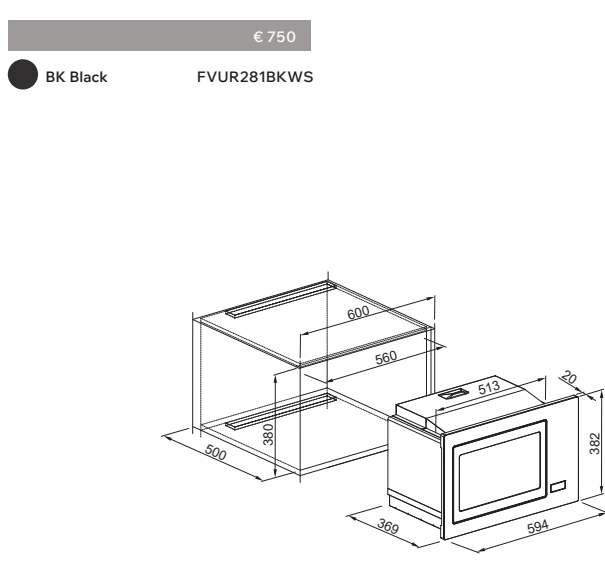

Plano Plus

Forno termoventilato con cornice colorata 60 cm, 8 funzioni

CARATTERISTICHE

MATERIALE = vetro con cornice colorata

FUNZIONI FORNO

ventilazione, resistenza superiore e inferiore, resistenza superiore e inferiore con ventilazione, resistenza circolare con ventilazione, easy clean, grill con ventilazione, grill, cottura multifunzionale (3D)

Display digitale con timer Led bianchi
 Easy Clean pulizia a vapore
 Regolazione della temperatura 40- 240 °C
 Cavità XXL: volume 80 Litri
 6 livelli di cottura con guide laterali cromate
 Manopole nere soft touch e maniglia nera
 Illuminazione interna alogena
 Porta fredda con triplo vetro
 Vetri e porta removibili
 Classe energetica A

ACCESSORI INCLUSI = 1 griglia, 1 leccarda smaltata

ACCESSORI OPZIONALI = 1 griglia air fry AGF001IN € 70

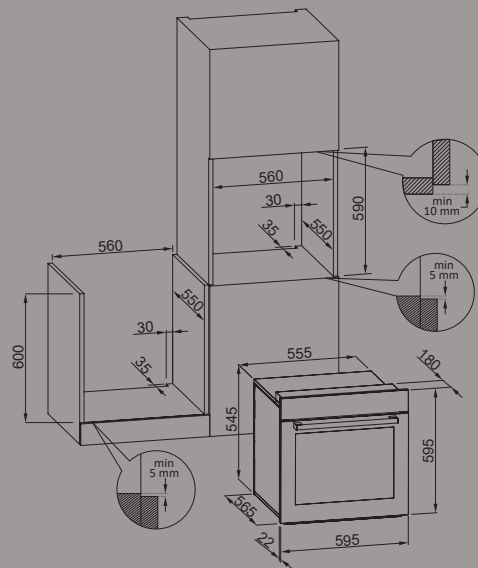

DISPLAY LED BIANCHI



PULIZIA A VAPORE



PORTA FREDDA



VETRO PORTA RIMOVIBILE



MANOPOLE SOFT TOUCH



CAVITÀ XXL



Plano Plus

Forno termoventilato con cornice colorata 60 cm, 8 funzioni



€ 950

● G40 Nero FGPP60240NS
Abbinabile a K86 Black



€ 950

● G48 Cemento FGPP60248NS
Abbinabile a K99 Concrete



€ 950

● G43 Tortora FGPP60243NS
Abbinabile a K89 Dove



€ 950

● M79 Nuvola FMPP60279NS
Abbinabile a K88 Cloud



€ 950

○ G68 Bianco FGPP60268NS
Abbinabile a K96 White



€ 950

● G51 Avena FGPP60251NS



€ 910

● IN Inox FIPP602INNS

Plano

Forno termoventilato con cornice colorata 60 cm, 7 funzioni

CARATTERISTICHE

MATERIALE = vetro con cornice colorata

FUNZIONI FORNO

Illuminazione con ventilazione, grill con ventilazione, resistenza inferiore con ventilazione, resistenza superiore e inferiore, resistenza superiore e inferiore con ventilazione, resistenza superiore con ventilazione, grill

Timer meccanico

Regolazione della temperatura 40-240 °C

Cavità XXL: volume 80 Litri

6 livelli di cottura con guide laterali cromate

Manopole nere soft touch e maniglia nera

Illuminazione interna alogena

Porta fredda con triplo vetro

Vetri e porta removibili

Classe energetica A

ACCESSORI INCLUSI = 1 griglia, 1 leccarda smaltata

ACCESSORI OPZIONALI = 1 griglia air fry AGF001IN € 70

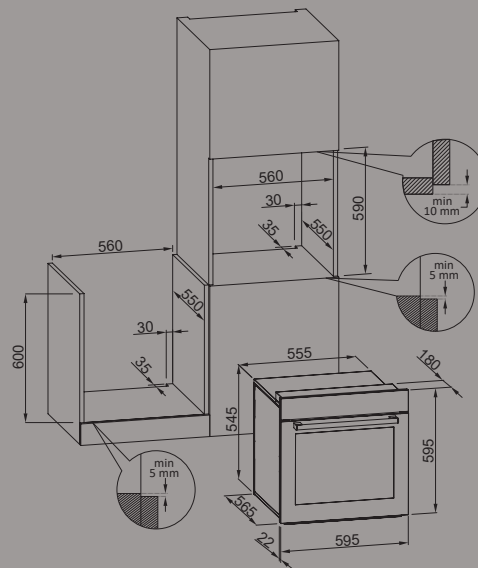

PORTA FREDDA



VETRO PORTA RIMOVIBILE



MANOPOLE SOFT TOUCH



CAVITÀ XXL



Plano

Forno termoventilato con cornice colorata 60 cm, 7 funzioni



€ 790

● G40 Nero FGSP60240NS
Abbinabile a K86 Black



€ 790

● G48 Cemento FGSP60248NS
Abbinabile a K99 Concrete



€ 790

● G43 Tortora FGSP60243NS
Abbinabile a K89 Dove



€ 790

● M79 Nuvola FMSP60279NS
Abbinabile a K88 Cloud



€ 790

○ G68 Bianco FGSP60268NS
Abbinabile a K96 White



€ 790

● G51 Avena FGSP60251NS



€ 750

● IN Inox FIAP602INNS

Plano MW

Forno microonde con cornice colorata 38 cm, 10 programmi

CARATTERISTICHE

MATERIALE = vetro con cornice colorata

FUNZIONI MICROONDE
10 programmi per diverse tipologie di cibo

Microonde
Microonde + grill
Scongellamento con inserimento tempo
Scongellamento con inserimento peso
Timer
Display digitale con timer Led bianchi
Regolazione della temperatura
Volume Cavità: 28 Litri
Cavità in acciaio inox
Comandi neri
Apertura porta: Sinistra
Sicurezza: funzione blocco bambini

ACCESSORI INCLUSI = 1 griglia, 1 piatto girevole in vetro da 315 mm

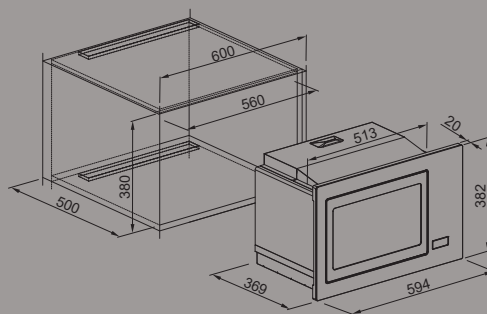

DISPLAY LED
BIANCHI



MICROONDE +
GRILL



SCONGELA-
MENTO



28
LITRI



Plano MW

Forno microonde con cornice colorata 38 cm, 10 programmi



€ 750

● G40 Nero FGSP28140WS
Abbinabile a K86 Black



€ 750

○ G68 Bianco FGSP28168WS
Abbinabile a K96 White



€ 750

● G43 Tortora FGSP28143WS
Abbinabile a K89 Dove



€ 750

● G48 Cemento FGSP28148WS
Abbinabile a K99 Concrete



€ 750

● M79 Nuvola FMSP28179WS
Abbinabile a K88 Cloud



€ 750

● G51 Avena FGSP28151WS



€ 650

● IN Inox FIAP281INWS



€ 750

● G59 Antracite FGSP28159WS

Country

Forno termoventilato in metallo colorato 60 cm, 7 funzioni

CARATTERISTICHE

MATERIALE = metallo colorato

FUNZIONI FORNO

illuminazione con ventilazione, grill con ventilazione, resistenza inferiore con ventilazione, resistenza superiore e inferiore, resistenza superiore e inferiore con ventilazione, resistenza superiore con ventilazione, grill

Timer Analogico

Regolazione della temperatura 40-240 °C

Cavità XXL: volume 80 Litri

6 livelli di cottura con guide laterali cromate

Manopole e maniglia finitura ottone

Illuminazione interna alogena

Porta fredda con triplo vetro

Vetri e porta removibili

Classe energetica A

ACCESSORI INCLUSI = 1 griglia, 1 leccarda smaltata

ACCESSORI OPZIONALI = 1 griglia air fry AGF001IN € 70

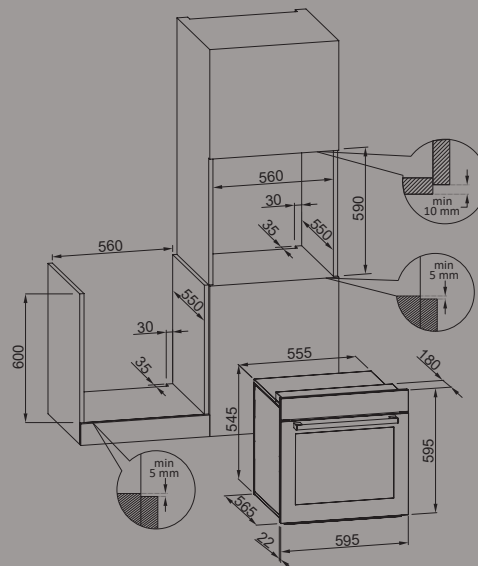

PORTA FREDDA



VETRO PORTA RIMOVIBILE



CAVITÀ XXL



Country

Forno termoventilato in metallo colorato 60 cm, 7 funzioni



€ 780



G59 Antracite

FGC060159NS



€ 780



G51 Avena

FGC060151NS



Cappa × Brio

Brio CAPPA

Cappa aspirante smaltata

CARATTERISTICHE

DIMENSIONI = 782 x 372 x 490 mm
CLASSE ENERGETICA = D
COMANDI = Slider
PORTATA MASSIMA = 368 m³/h
PRESSIONE = 218 Pa
RUMOROSITÀ MASSIMA = 58 dbA
BOCCA USCITA = 120

€ 800

● G40 Nero KGPB8040M

€ 90

● Accessorio filtro carbone AFC01304

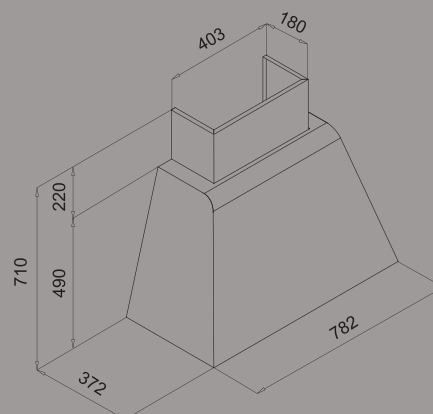

Urban CAPPA

Cappa aspirante smaltata

CARATTERISTICHE

DIMENSIONI = 493 x 486 x H 406 mm

CLASSE ENERGETICA = D

COMANDI = Slider

PORTATA MASSIMA = 520 m³/h

PRESSIONE = 151 Pa

RUMOROSITÀ MASSIMA = 65 dbA

BOCCA USCITA = 120

€ 680



G40 Nero

KGPUR040M

€ 90



Accessorio filtro
carbone

AFC01305

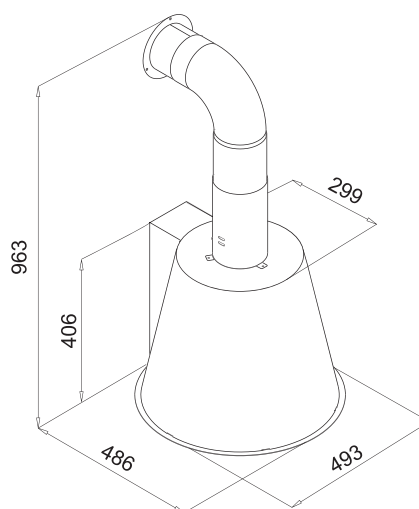

elleci zero

Libertà da rifiuti e cattivi odori

Il dissipatore di rifiuti alimentari è l'alleato essenziale per una cucina sempre pulita e in ordine. Durante la preparazione dei cibi o a fine pasto, questo piccolo elettrodomestico dalle funzionalità avanzate ti permette di smaltire immediatamente gli scarti organici nello scarico del lavello, senza dover più riempire la pattumiera dell'umido.

Il sistema di smaltimento rifiuti Elleci Zero trita e scarica i residui organici nelle acque reflue in pochi, semplici gesti:

1. Apri l'acqua corrente fredda
2. Attiva il dissipatore con l'Air Switch
3. Inserisci gli avanzi di verdura, frutta, lische di pesce, gusci, ossa di pollo ecc...
4. Lascia scorrere l'acqua fino a completo smaltimento

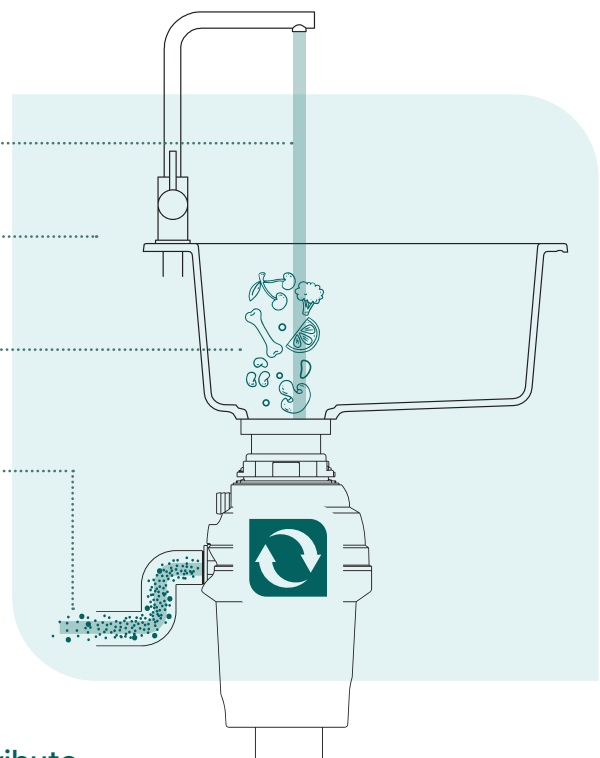

Le buone abitudini quotidiane sono il miglior contributo per un futuro sostenibile



Promuove il riciclo dei rifiuti organici



Riduce le emissioni di CO2 provocate dal trasporto



Minimizza le emissioni di metano generate dai rifiuti in discarica



Supporta il processo di depurazione delle acque



Facilita la produzione di biogas e compost

**zero
waste**

Riduce i rifiuti
organici
e mantiene la cucina
pulita e salubre

**zero
odour**

Elimina i cattivi odori
causati
dall'accumulo
di rifiuti

**zero
risk**

Assolutamente
sicuro
anche con bambini
e animali domestici

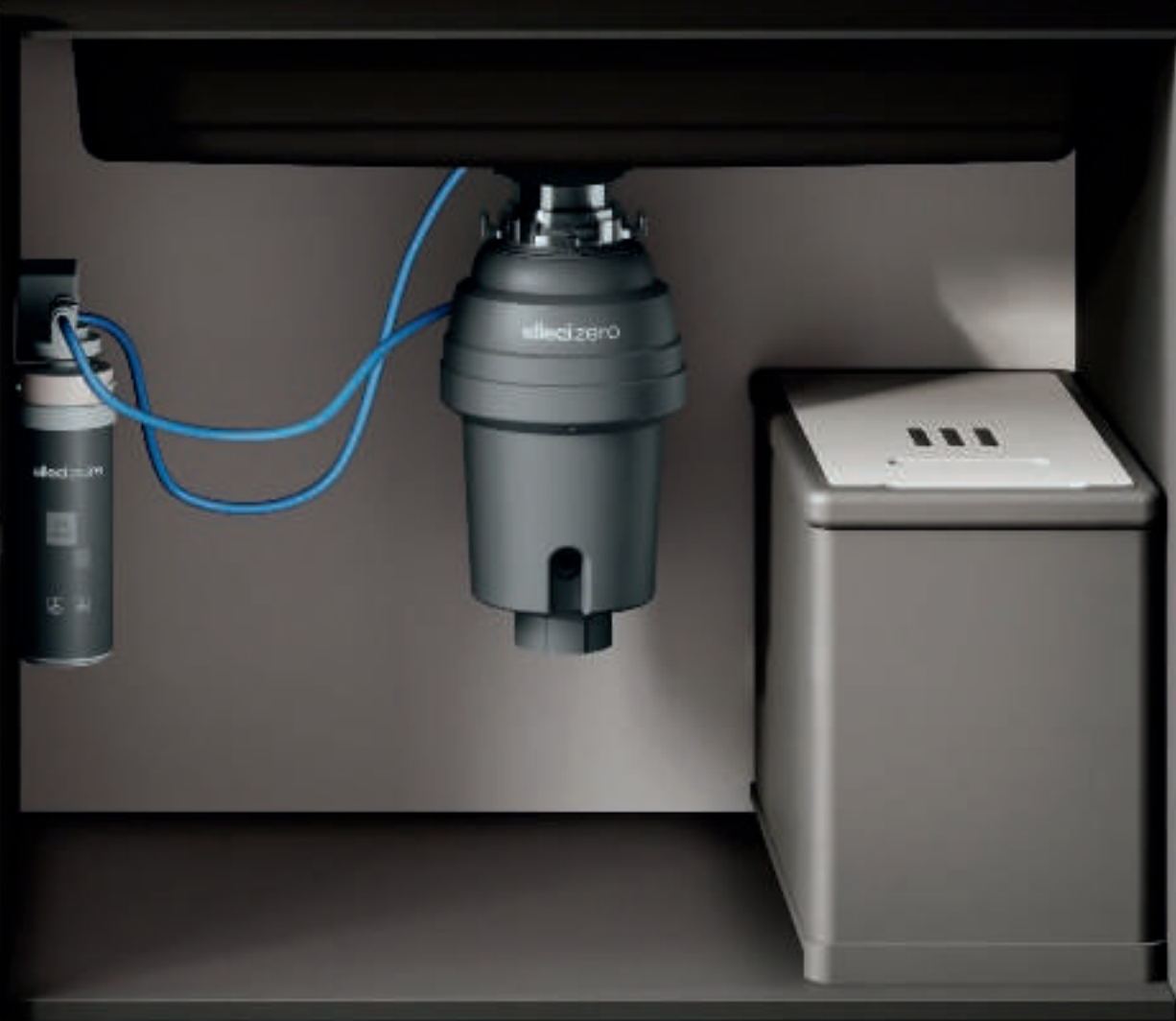

elleci zero

Facile e sempre pronto all'uso

Elleci Zero è progettato per garantire massima sicurezza, potenza e velocità di smaltimento, riducendo al minimo vibrazioni, rumorosità e ingombro nella base lavello.



Smaltimento istantaneo



Sistema reset che garantisce totale sicurezza



Protezione antibatterica e antiodore



Ultra silenzioso



Flangia e componenti in acciaio inox



Interruttore pneumatico ad aria "Air Switch" incluso



Installazione facile



Dimensioni compatte



Compatibile con lavelli in materiale composito e acciaio

2 Soluzioni studiate per soddisfare le esigenze di ogni nucleo familiare

Elleci Zero Serie 100



CARATTERISTICHE

Dimensioni	401 x 194 mm
Potenza	0,75 kW
Tensione VAC	220/240 V
Frequenza	50-60 Hz
Assorbimento	3,4 A
Giri minuto	2800 RPM
Peso	5,4 Kg
Capacità	1070 ml

SERIE
100

TDZ100GR € 450

Elleci Zero Serie 60



CARATTERISTICHE

Dimensioni	376 x 194 mm
Potenza	0,46kW
Tensione VAC	220/240 V
Frequenza	50-60 Hz
Assorbimento	2,1 A
Giri minuto	2500 RPM
Peso	5 Kg
Capacità	860 ml

SERIE
60

TDZ060GR € 380

ACCESSORI INCLUSI



Gomito di fissaggio



Gomma paraspruzzi removibile e lavabile anche in lavastoviglie



Spingitore rifiuti



Tappo standard



Air Switch: attuatore pneumatico (pulsante di accensione ad aria, non elettronico)

ACCESSORI OPZIONALI



Flangia dissipatore piletta quadrata
ATQ01300 € 38



Radiocomando accensione
ARP01300 € 84



elleci beauty



200 ml
DLL01603 € 40

DEEP CLEANER Smacchiante

Detergente spray con azione smacchiante, rimuove le macchie più ostinate su tutti i lavelli e lavabi in composito Elleci.



200 ml
DLA01603 € 28

DAILY CLEANER Anticalcare

Detergente spray anticalcare, scioglie le incrostazioni rispettando le superfici. È indicato per una pulizia periodica dei lavelli e lavabi in composito Elleci.



100 ml
DLP01601 € 30

Beauty Protector

Detergente spray protettivo, salvaguarda da sporco, residui calcarei e mantiene la bellezza del prodotto nel tempo ravvivando la colorazione e aumentandone l'idropellenza.

KEB00103 € 80

Beauty Kit

Tre prodotti irrinunciabili per il trattamento completo di cura e pulizia dei lavelli in composito: lo Smacchiante agisce in profondità, il detergente Anticalcare elimina le incrostazioni e il Beauty Protector ravviva la colorazione.



250 ml
DLA01602 € 30

DAILY CLEANER Clean Power

Detergente spray di pulizia specifico per superfici colorate e smaltate. È indicato per una pulizia quotidiana dei miscelatori e degli elettrodomestici colorati Elleci.



DKP01000 € 18

FAST CLEAN Kit Spugne

Kit composto da 3 spugne antigraffio dotate di doppio strato utile a rimuovere lo sporco, anche il più intenso. La parte bianca agisce senza graffiare le superfici delicate, mentre la parte blu morbida ha un potere assorbente.

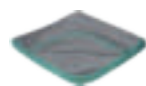

DKP01001 € 24

FAST CLEAN Panni in microfibra

Kit composto da 2 panni in microfibra con speciale motivo a scacchiera ad alta assorbenza per asciugare il lavello e togliere ogni residuo lasciando inalterata la superficie.

Cura e manutenzione

Elleci Beauty è la linea formulata per esaltare e proteggere la bellezza dei lavelli in composito. Una cura quotidiana che mantiene inalterata nel tempo la qualità dei prodotti Elleci.

I detergenti Elleci Beauty garantiscono una pulizia profonda e delicata, giorno dopo giorno. Ogni formula nasce da un'attenta ricerca ed è studiata per eliminare anche le macchie più ostinate, rimuovere germi e batteri, sciogliere le incrostazioni e preservare l'intensità del colore.

La routine quotidiana per un lavello sempre perfetto

Rimuovere eventuali macchie utilizzando una spugna morbida e un detergente neutro per i piatti o un prodotto specifico della linea Elleci Beauty.



Risciacquare abbondantemente le superfici utilizzando acqua tiepida.



Asciugare con cura la superficie con un panno morbido o in microfibra per impedire la formazione di depositi di calcare.























Per prevenire la formazione delle macchie di calcare sulla superficie, si raccomanda di eseguire una pulizia più approfondita una o due volte alla settimana utilizzando un detergente anticalcare disincrostante come lo spray anticalcare Daily Clean della linea Elleci Beauty.



Ulteriori avvertenze e consigli



Spare parts

	KIT PILETTA FLOW PRO INOX, UNA VIA SCARICO PILETTA UNA VIA DA 3-1/2" CON TAPPO CESTELLO FLOW PRO INOX E TUBO CORRUGATO, SENZA TROPPOPIENO	CODICE WPT90CTPLUXF EURO 35		KIT PILETTA FLOW NERA CHIUSA SCARICO PILETTA FLOW NERA IN +TECNOPOLIMERO 3-1/2" CHIUSA CON TAPPO CESTELLO	CODICE WPT90STPLUXFB-BK EURO 12
	KIT TROPPOPIENO RETTANGOLARE TROPPOPIENO CON USCITA RETTANGOLARE SLIME COVER INOX, COMPLETO DI ATTACCHI	CODICE KTSMELL EURO 10		COVER PILETTA INOX COVER PILETTA GHOST INOX	CODICE ACPP1000IN EURO 10
	KIT PILETTA FLOW PRO CON TROPPOPIENO SLIM NERO SCARICO PILETTA UNA VIA DA 3-1/2" CON TAPPO CESTELLO FLOW PRO NERO E TUBO CORRUGATO CON TROPPOPIENO SLIM "ELLECI" NERO	CODICE KITWPT-F-1VSELL-BK EURO 115		COVER PILETTA NERA COVER PILETTA GHOST NERA	CODICE ACPP1000BK EURO 10
	KIT PILETTA FLOW PRO CON TROPPOPIENO SLIM GUN METAL - SCARICO PILETTA UNA VIA DA 3-1/2" CON TAPPO CESTELLO FLOW PRO GUN METAL E TUBO CORRUGATO CON TROPPOPIENO SLIM "ELLECI" GUN METAL	CODICE KITWPT-F-1VSELL-GM EURO 100		KIT PILETTA UNA VIA INOX SCARICO PILETTA UNA VIA DA 3-1/2" CON TAPPO CESTELLO E TUBO CORRUGATO, SENZA TROPPOPIENO	CODICE WBB90CTPLUXR EURO 10
	CESTELLO SCARICO FLOW PRO INOX TAPPO CESTELLO FLOW PRO INOX SPAZZOLATO	CODICE TAPF01IN EURO 25		KIT PILETTA CHIUSA INOX SCARICO PILETTA 3-1/2" CHIUSA CON TAPPO CESTELLO	CODICE WBB90STPLUXR EURO 10
	CESTELLO SCARICO FLOW PRO NERO TAPPO CESTELLO FLOW PRO NERO	CODICE TAPF01BK EURO 95		KIT PILETTA UNA VIA, SCARICO QUADRATO SCARICO PILETTA 3-1/2" CHIUSA CON TAPPO CESTELLO	CODICE WPT90CTPLUXQ EURO 40
	CESTELLO SCARICO FLOW PRO GUN METAL TAPPO CESTELLO FLOW PRO GUN METAL	CODICE TAPF01GM EURO 70		KIT PILETTA SCARICO PILETTA CHIUSA DA 70mm, CON TAPPO CESTELLO, SET ESCLUSIVO PER LAVELLI EASY 325 e EASY 425	CODICE WPT70STPLUXA EURO 12
	KIT PILETTA FLOW CON TROPPOPIENO TONDO INOX SCARICO PILETTA UNA VIA DA 3-1/2" CON TAPPO CESTELLO FLOW INOX E TUBO CORRUGATO CON TROPPOPIENO TONDO "ELLECI" INOX	CODICE KITWPT-FB-1VTELL-IN EURO 30		KIT TROPPOPIENO TONDO TROPPOPIENO CON USCITA TONDA E COVER INOX, COMPLETO DI ATTACCHI	CODICE KTTMELL EURO 8
	KIT PILETTA FLOW CON TROPPOPIENO TONDO NERO - SCARICO PILETTA UNA VIA DA 3-1/2" CON TAPPO CESTELLO FLOW NERO IN TECNOPOLIMERO E TUBO CORRUGATO CON TROPPOPIENO TONDO "ELLECI" NERO	CODICE KITWPT-FB-1VTELL-BK EURO 35		KIT SIFONE UNA VIA SIFONE ISPEZIONABILE SALVASPAZIO A UNA VIA PER LAVELLI UNA VASCA	CODICE COMPSIF1V EURO 8
	KIT PILETTA FLOW INOX CHIUSA SCARICO PILETTA FLOW INOX 3-1/2" CHIUSA CON TAPPO CESTELLO	CODICE WPT90STPLUXFB EURO 12		KIT SIFONE DUE VIE SIFONE ISPEZIONABILE SALVASPAZIO A DUE VIE PER LAVELLI DUE VASCHE	CODICE COMPSIF2V EURO 10

lavelli in composito

lavelli in composito

	KIT SIFONE DUE VIE SFASATE SIFONE ISPEZIONABILE SALVASPAZIO A DUE VIE SFASATE, PER LAVELLI CON DUE VASCHE	CODICE COMPSIF2VU EURO 10		SET GOMITO FISSAGGIO GOMITO DI FISSAGGIO CON GUARNIZIONI	CODICE IKT90003 EURO 18
	SET GANCI SOPRATOP N.6 GANCI FISSAGGIO AD INCLINAZIONE 23; CON VITI PREMONTATE E SPESSORI IN PLASTICA, PER FISSAGGIO LAVELLO COMPOSITO	CODICE BOXGAN06 EURO 12		KIT PULSANTE PNEUMATICO PULSANTE PNEUMATICO CON TUBO IN GOMMA E DADO DI FISSAGGIO, PER L'ACCENSIONE DEL DISSIPATORE	CODICE IKT90002 EURO 30
	SET GANCI SOPRATOP N.6 GANCI FISSAGGIO AD INCLINAZIONE 90; CON VITI PREMONTATE E SPESSORI IN PLASTICA, PER FISSAGGIO LAVELLO COMPOSITO	CODICE BOXGAN06S EURO 12		PARASCHIZZI PARASCHIZZI IN GOMMA CON ALETTE	CODICE PPT90010 EURO 10
	SET GANCI SOTTOTOP N.6 GANCI FISSAGGIO CON VITI PER LAVELLO COMPOSITO AD INSTALLAZIONE SOTTOTOP	CODICE AKS01301 EURO 18		RADICOMANDO RADIOCOMANDO ACCENSIONE DISSIPATORE	CODICE ARP01300 EURO 84
	FRESA PER FORATURA N.6 GANCI FISSAGGIO FRESA A TAZZA DIAMANTATA, DIAMETRO 35mm PER EFFETTUARE FORO MISCELATORE SU LAVELLO COMPOSITO	CODICE FRES17 EURO 18		SPINGITORE RIFIUTI SPINGITORE RIFIUTI IN PLASTICA	CODICE PPT90000 EURO 18
	BEAUTY KIT KIT COMPOSTO DA TRE PRODOTTI PER IL TRATTAMENTO COMPLETO DI CURA E PULIZIA DEI LAVELLI IN COMPOSITO	CODICE KEB00103 EURO 80			
	FILTRO ELLECI PURE FILTRO MULTI-AZIONE 0,5 MICRON CON CARBONI ATTIVI E SALI D'ARGENTO	CODICE RFPMLM EURO 100			
	TAPPO TAPPO DISSIPATORE TONDO	CODICE IKT90004 EURO 15			
	KIT FLANGIA RACCORDO FLANGIA DI RACCORDO PER DISSIPATORE ELLECI CON GUARNIZIONI, PARASCHIZZI IN GOMMA, ANELLO E GHIERA DI FISSAGGIO	CODICE IKT90001 EURO 20			
	FLANGIA DI RACCORDO QUADRATA PER DISSIPATORE ELLECI PER LAVELLI CON SCARICO QUADRATO	CODICE ATQ01300 EURO 38			

lavelli in composito

filtraggio

dissipatori

dissipatori

elleci care

Sempre più vicini a te

Elleci si impegna a coltivare e rafforzare il rapporto di fiducia con i clienti. Dedichiamo un'attenzione scrupolosa alle esigenze dei consumatori, dalla fase pre-vendita fino alla fase post-vendita, garantendo un'assistenza continua e la disponibilità a risolvere qualsiasi problematica per assicurare una soddisfazione duratura

Il servizio web dedicato all'assistenza clienti

Sul sito www.elleci.com nella pagina Supporto & Assistenza in pochi click potrai:

- richiedere informazioni sui prodotti
- cercare il punto vendita più vicino a te
- ricevere consigli e istruzioni per cura e manutenzione
- aprire una pratica di assistenza



Elleci Supporto e Assistenza

Il numero verde a tua disposizione

Elleci ha potenziato il **Customer Care**: un team qualificato è attivo dal lunedì al venerdì dalle 8.30 alle 13.00 e dalle 14.00 alle 17.30, raggiungibile da numero fisso e da smartphone.

Ci impegniamo a fornirti l'assistenza di cui hai bisogno in ogni momento del tuo percorso d'acquisto.

 **NUMERO VERDE**
800 800 803

Il servizio è disponibile esclusivamente per il territorio italiano, Città del Vaticano e Repubblica di San Marino; negli altri paesi per l'assistenza tecnica rivolgersi direttamente al rivenditore da cui è stato acquistato il prodotto Elleci.

Indice collezioni



Best workstation
pag. 26

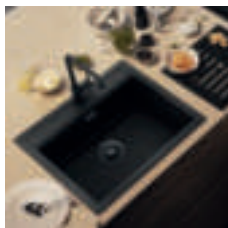

**Best workstation
Total black**
pag. 32

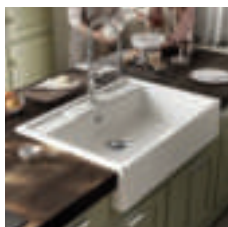

Spazio
pag. 36

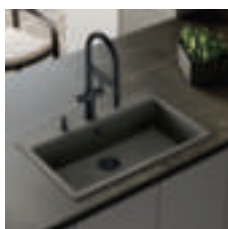

Time workstation
pag. 42

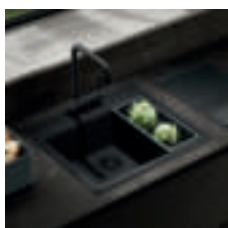

**Time workstation
Total black**
pag. 48

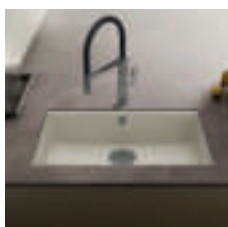

Time undermount
pag. 52

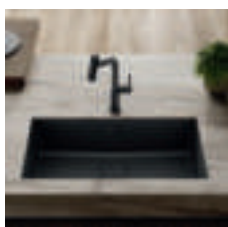

**Time undermount
Total black**
pag. 55

lavelli in composito

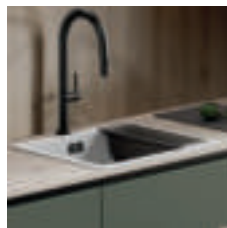

Zen
pag. 58

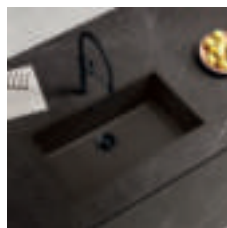

Zen F
pag. 64



Karisma
pag. 70

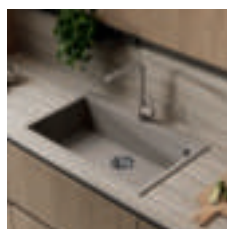

Quadra
pag. 76

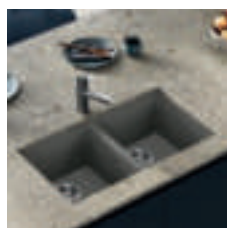

Quadra sottotop
pag. 86



Fox
pag. 96

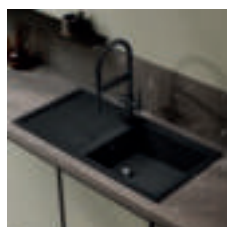

Best
pag. 102

lavelli in composito

lavelli in composito

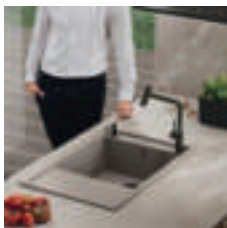

Unico
pag. 108

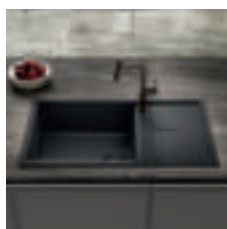

**Unico
Total black**
pag. 117

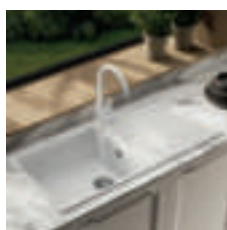

Ego
pag. 120

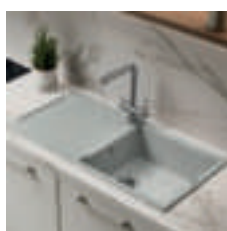

Easy
pag. 126



Life
pag. 134

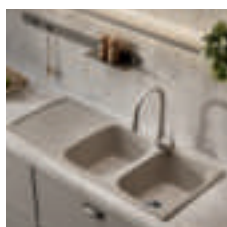

Master
pag. 144

lavelli inox



Lavelli Inox
pag. 150

accessori

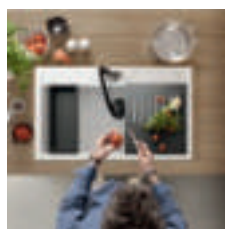

Accessori
pag. 166

miscelatori



**Miscelatori filtranti
Elleci Pure**
pag. 180

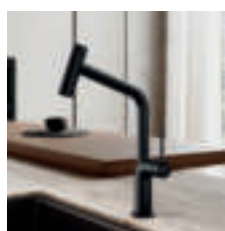

Miscelatori
pag. 184

Indice collezioni



Urban induction
pag. 200



Urban glass
pag. 202



Plano
pag. 204



Style country
pag. 208



Style
pag. 212

piani cottura



Urban Plus
pag. 214

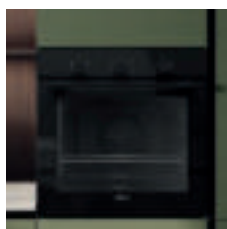

Urban
pag. 215



Urban MW
pag. 215



Plano Plus
pag. 216

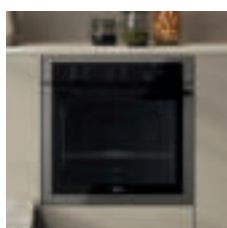

Plano
pag. 218

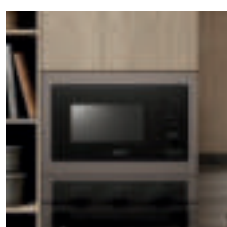

Plano MW
pag. 220



Country
pag. 222

forni

cappe

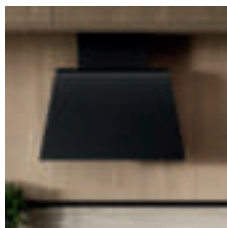

Cappe
pag. 224

dissipatori



Elleci Zero
pag. 226

pulizia e cura



Elleci Beauty
pag. 230

PROJECT COORDINATION

Elleci S.p.a.

CONCEPT AND DESIGN

Mama Studio

PRINTED BY

Sincromia

2025

Elleci S.p.A.

Strada Longitudinale A 1258
Zona industriale Mazzocchio
04014 Pontinia (LT) - Italy

Tel. +39 0773.84.00.36

elleci@elleci.it
www.elleci.com



